

USER'S MANUAL

HDD Motion Music Player

m:robe **MR-500i**

OLYMPUS

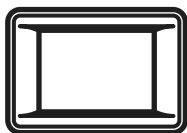

m:robe

For customers in North and South America

For customers in USA

Declaration of Conformity

Product Name : DIGITAL AUDIO PLAYER
Model Number : m:robe MR-500i
Trade Name : OLYMPUS
Responsible Party : **OLYMPUS IMAGING AMERICA INC.**
Address : Two Corporate Center Drive, PO Box 9058, Melville,
NY 11747-9058 U.S.A.
Telephone Number : 1-631-844-5000

Tested To Comply With FCC Standards
FOR HOME OR OFFICE USE

This device complies with Part 15 of the FCC rules. Operation is subject to the following two conditions:

- (1) This device may not cause harmful interference.
- (2) This device must accept any interference received, including interference that may cause undesired operation.

FCC Notice

• Radio and Television Interference

Change or modifications not expressly approved by the manufacturer may void the user's authority to operate this equipment. This equipment has been tested and found to comply with the limits for a Class B digital device, pursuant to Part 15 of the FCC Rules.

These limits are designed to provide reasonable protection against harmful interference in a residential installation.

This equipment generates, uses, and can radiate radio frequency energy and, if not installed and used in accordance with the instructions, may cause harmful interference to radio communications.

However, there is no guarantee that interference will not occur in a particular installation.

If this equipment does cause harmful interference to radio or television reception, which can be determined by turning the equipment off and on, the user is encouraged to try to correct the interference by one or more of the following measures:

- Adjust or relocate the receiving antenna.
- Increase the distance between the equipment and receiver.
- Connect the equipment to an outlet on a circuit different from that to which the receiver is connected.
- Consult your dealer or an experienced radio/TV technician for help. Only the OLYMPUS-supplied cables should be used to connect this product to other products.

Any unauthorized changes or modifications to this equipment would void the user's authority to operate.

For customers in Canada

This Class B digital apparatus complies with Canadian ICES-003.

For customers in Europe



“CE” mark indicates that this product complies with the European requirements for safety, health, environment and customer protection. “CE” mark players are intended for sales in Europe.

Introduction

Thank you for purchasing the Olympus HDD Motion Music Player m:robe MR-500i.

The reference manuals for your m:robe consist of the following three guides. To ensure correct and safe use of your m:robe, please read the manuals before using your m:robe and refer to them whenever necessary during use.

QUICK START GUIDE

Contains instructions for setup.

You can start using your m:robe immediately after reading this guide.

BASIC MANUAL

Contains instructions for basic operations.

USER'S MANUAL (CD-ROM Edition) (this manual)

Contains a description of all m:robe functions.

Use this manual to get the most out of the features and functions of your m:robe.

- The contents of this manual are subject to change without notice. Contact an authorized Olympus service center in the enclosed Authorized Distributors List with the product name and model number for the latest information.
- While every care has been taken in the preparation of this manual, if you find any errors, omissions, or points which are unclear, please contact an authorized Olympus service center.
- The contents of this manual may not be reproduced in whole or in part except for personal use. It may not be transferred without permission.
- Olympus accepts no responsibility for losses suffered by the customer or a third party as a result of improper use of this product.
- Olympus accepts no responsibility for any damage due to a loss of data resulting from malfunction of this product, repair by a third party not authorized by Olympus, or other reason.
- Illustrations in this manual may not be same as the actual product.

Voluntary radio interference control

- This equipment is a Class B digital device based on the standards of the Voluntary Control Council for Interference by Information Technology Equipment (VCCI). This equipment is designed for use in a home environment, but it may cause interference to radio or television reception if used in the vicinity of the receiver.
- Use of this product may be restricted in places in such as an aircraft or hospital; follow regulations regarding usage of this product in such places.
- Use of a cable other than that specified herein when connecting the equipment may result in VCCI limits being exceeded. Use only the specified cable.

Trademarks/Fonts

- m:robe and m:trip are trademarks of OLYMPUS CORPORATION.
- Windows is a registered trademark of Microsoft Corporation.
- All other company and product names are registered trademarks and/or trademarks of their respective owners.
- The screen fonts used by this product belong to Ricoh corporation.

Copyright and copyright protection feature (DRM)

By the Copyright Act, any audio files and audio CDs downloaded from the Internet without the copyright holder's permission may not be reproduced, distributed, publicized/re-publicized on the Internet, or converted into MP3 or WMA files for the purpose of commercial business or sale.

A WMA file may be provided with DRM (Digital Right Management) for copyright protection. DRM limits the file to copy or distribute audio files that are converted (ripped) from an audio CD or downloaded from music distribution services.

You can transfer the WMA file with DRM to m:robe by using the supplied Music/Photo Organization Software "m:trip." In case of audio files that you purchased from online music distribution service, the number of times you can transfer to m:robe may be restricted.

About stored music and photos

Olympus accepts no responsibility for any damage due to loss or inability to play back music or photo data resulting from malfunction of this product or the computer.

About sample images, tracks and templates incorporated into this product

The copyrights of the sample images, tracks, and templates are owned by the artists or their suppliers.

These sample materials may not be reproduced or used for profit and may not be transferred or resold to third parties.

Failure to comply with these limitations may result in penalties for infringement of copyrights.

Olympus accepts no responsibility in cases where these copyrights are violated.

Design rule for Camera File system (DCF)

The standards for camera file systems referred to in this manual are the “Design rule for Camera File system/ DCF” standards stipulated by the Japan Electronics and Information Technology Industries Association (JEITA).

● How to use this manual

This manual contains a table of contents and index which allows you to immediately refer to a function you would like to use or find information on.

Searching from the table of contents (📖 page 8)

The titles in this manual are listed.

Titles are arranged according to the task you want to perform. For example, there is a chapter on preparative operations of your m:robe, a chapter on basic music playing operations, and a chapter on basic shooting operations.



Searching from the index (📖 page 114)

Terms used in this manual such as function names and names of parts are listed in alphabetic order.

While reading this manual if you come across a term you do not understand or would like more information on, the index will refer you to the page in which the term is used.

What do the marks mean?

This manual uses the following marks:

Mark	Meaning
 Tip	Indicates useful information for convenient m:robe operation.
 Note	Indicates directions and cautions when you operate your m:robe.
	Indicates a reference page.

Features

- **With a hard disk drive of 20 GB, you can transfer and store approximately 5,000 music tracks^{*1} or 20,000 photos^{*2} to enjoy anytime, anywhere.**
- **You can enjoy three features: MUSIC, PHOTO, and REMIX^{*3}.**
- **The supplied Music/Photo Organization Software “m:trip” enables you to visit music download stores by one-click to purchase music tracks easily.**
- **You can import music from audio CDs and photos to the Music/Photo Organization Software “m:trip” and add to your library.**
- **You can synchronize your music/photo/remix database between your m:robe and the supplied Music/Photo Organization Software “m:trip” easily.**
- **You can print photos easily with your m:robe connected to a PictBridge-compatible printer.**
- **You can enjoy music, photos, and remixes on your TV.**
- **You can use your m:robe as an external hard disk drive of your computer.**

^{*1} When storing music tracks only.

For typical 4-minute tracks recorded at 128 kbps in WMA format.

^{*2} When storing 4 megapixel photos.

^{*3} The remix image player enables you to combine music tracks and photos with a remix template and play them together.

● Table of contents

Introduction	3
How to use this manual	6
Features	7
Table of contents	8

Read this first **11**

Safety Precautions	11
Controls: location and function	18
Device	18
Remote	20
Preventing unintentional operations	22

Getting Started **23**

Setting up your m:robe	23
Charging the battery	23
Setting up m:trip	24
Installing the Music/Photo Organization Software “m:trip”	25
Importing music/photos to m:trip	26
Transferring music/photos from m:trip to your m:robe	27
Turning on your m:robe	27
Connecting to your computer	27
Starting transfer	29
Disconnecting your m:robe from your computer	29
About synchronization between your m:robe and m:trip	30

MUSIC **32**

Listening to the music	32
Basic operations of music playback	32
Playing tracks in random order/repeatedly	35
Viewing track information	36
Viewing lyrics	37
Using the equalizer	38
Searching and playing the desired track	40
How to narrow down the search	41
Arranging your audio files	45
Deleting a track from your m:robe	45

Adding a track to “FAVORITES”	45
-------------------------------------	----

📷 PHOTO	46
----------------	-----------

Taking a photo	46
Basic operations of the “SHOOT” mode	46
Shooting photos	48
Setting the album to store captured photos	49
Setting image size	50
Setting the photo light	51
Viewing/searching for a photo	52
Basic operations of the “VIEW” mode	52
Searching by thumbnails of all photos in your m:robe	54
Searching by album	56
Searching by shooting date	57
Slide show	59
Removing photos from albums	60
Deleting photos from your m:robe	62
Adding a photo to “FAVORITES”	64
Adding a photo to an album	65

📺 REMIX	67
----------------	-----------

Creating a remix cube	67
Basic operations of the “SET” mode	68
How to create a remix cube	70
Playing a remix cube	78
How to play a remix cube	78
Playing a remix cube repeatedly	79

Printing photos	80
------------------------	-----------

Printing with a PictBridge-compatible printer	80
Connecting to your printer	81
Printing photos	84

Playing back on a TV	93
Setting the video signal type	93
Connection and playback on a TV.	94



Setting your m:robe	96
Setting the display language	96
Setting the date and time	97
Turning the beep sound on/off.	99
Setting the brightness and the backlight time of the LCD screen	100
Setting the Off Timer.	101
Resetting the settings	102

Additional Information	103
Using your m:robe as an external hard disk drive	103
Cleaning.	103
Notes when you dispose of your m:robe	104
How to remove the built-in battery	104
Troubleshooting	106
Rebooting your m:robe	108
Error message list	109
Service and maintenance	111
Specifications.	112
Index	114
Before you contact us	116

Read this first

Safety Precautions

Before using this product, read this first to ensure that you know how to operate it safely and correctly. Various symbols are used to warn of hazards to yourself and others and prevent damage to property through misuse of this product. The symbols and their meanings are explained below.

 Danger	This symbol indicates that failure to observe the instructions will likely result in serious injury or possibly even death.
 Warning	This symbol indicates that failure to observe the instructions may result in serious injury or possibly even death.
 Caution	This symbol indicates that failure to observe the instructions may result in injury or damage to property.

Precautions when handling this product

Warning

- **Do not use in a place where there is running water.** Doing so may cause electric shock, fire, over-heating or explosion. Take extra caution when using this product in rain, snow, at the seaside or a waterfront. Also, do no use in a bathroom or shower room.
- **Do not use or leave this product near a stove or fire.** Doing so may cause over-heating, explosion or fire. Be especially careful during charging. Also, when the AC cord cover is damaged, it may cause fire or electric shock.
- **Do not use in the presence of flammable or explosive gas.** Do not use this product if there is the possibility of the presence of such gases in the air. Failure to do so could result in fire or explosion.
- **Do not look at the photo light directly at a close distance.** Doing so may cause eye injury or accident by dazzling eyes or sudden surprise.
- **Keep out of the reach of children.** Do not let children use this product without adult supervision.
- **Avoid prolonged contact with the device, the AC adapter and the cradle while charging.** The device and the cradle become hot during charging and during continued use with the specified AC adapter. Prolonged contact with the device during use could result in minor burns.
- **Do not use or store this product for a long time in an environment where there is a lot of dust, dampness, smoke or steam.** This could result in fire or electric shock.

- **Stop using this product immediately when thunder has occurred.** Failure to do so may cause electric shock. Disconnect the AC adapter and refrain from using.
- **Do not use while walking or driving.** Doing so may cause injury or accident. Never watch the on screen display while driving.
- **Do not let any water or other foreign object get inside the device.** Should the device be dropped in water, or water gets into the internal parts, it could be result in fire or electric shock. Turn the power off immediately and contact your nearest Olympus service center.
- **Should you notice an unusual smell, over-heating, discoloration, modification or smoke, stop using this product immediately.** Leaving as it is may cause fire, electric shock or burns. Disconnect the AC adapter, turn off the device immediately, and contact your nearest Olympus service center.
- **Should you notice leakage or an unusual smell, keep this product away from fire.** Failure to do so may cause explosion or fire.
- **Do not attempt to disassemble or modify this product or AC adapter.** Such action could lead to electric shock or injury by high-voltage parts inside.
- **Do not break, damage or modify the AC cord. Also, do not put a heavy object on it, pull or bend forcefully.** Doing so may cause damage to the AC cord, fire or electric shock.



Caution

- **Never connect or disconnect the power plug with wet hands.** This could result in electric shock.
- **Do not leave this product in places of high temperature, such as in a sun-heated car.** Doing so could result in battery leakage, deterioration of parts or fire. Do not cover the AC adapter or cradle with anything such as a cloth or blanket when in use. This may cause overheating or fire.
- **Use only the specified AC adapter.** Use of an unspecified adapter may result in damage or malfunction of the device or power source. Olympus is not responsible for any damages arising from use of an unauthorized adapter.
- **Do not damage the AC cord by pulling it and do not attempt to extend it.** Always disconnect the AC adapter by pulling the plug not the cord. Discontinue use of the AC adapter immediately in the event of the following and contact your nearest Olympus service center.
 - The plug or cord is hot, there is a smell of burning, or smoke is emitted.
 - The plug or cord is damaged or ruptured, or the plug connection is faulty.

- **Avoid touching the metal case of the device for long periods of time.**
 - The device becomes hot during continued use. Prolonged contact with metal parts may result in minor burns.
 - If exposed to extreme low temperatures, the temperature of the device exterior will also drop. This may cause injury by the skin adhering to the device when picked up. Wear gloves when handling.
- **Do not touch any leakage that has occurred.** Battery leakage, etc., may have occurred. Getting the liquid into your eyes or touching it may cause injury. In such a case, wash immediately with clean water and seek medical attention immediately.

Conditions for use of this product

- This product contains precision electronic parts. Avoid using or leaving this product for long periods of time in the following places as this could result in failure or malfunction.
 - places of high temperature and high humidity or where the temperature and humidity fluctuate greatly, such as in direct sunlight, on the beach in summer, in a car with the windows closed, or next to air conditioning equipment or a humidifier
 - near equipment with strong magnets such as speakers
 - places where there is a lot of sand, dust or dirt
 - near fire
 - near water
 - places that are subject to vibration
- Avoid dropping or hitting this product or subjecting it to severe vibration or impact.
- Keep this product away from magnetic objects. Failure to do so could result in inability to read data. Leaving this product near magnetic-based data storage, such as credit cards, floppy disks, etc., may result in their becoming unusable.
- Do not take a picture or leave this product with the lens aimed directly at the sun. Doing so may cause color-fade or burn-in on the image pickup device.
- If the device is subjected to a sudden temperature change, for example by bringing it from a cold place into a warm room, condensation may form on the inside. Use the device after the temperature difference has subsided.

Precautions regarding the liquid crystal display

- Do not apply excessive pressure to the liquid crystal display. This may cause smears, prevent photos from being played back properly, or damage the liquid crystal display. Should the liquid crystal display break, avoid getting any of the liquid crystal in your mouth. If it contacts your skin or clothing, wash it off immediately with soap and water.
- Lines, like strips of light, may appear at the top or bottom of the liquid crystal display. This is not a malfunction.
- When photographing an oblique subject, the subject may appear on the screen with ragged edges. This is not a malfunction. The ragged edges will disappear when the photo is played back.
- In general, the lower the temperature, the longer it takes the liquid crystal display to turn on. Photos may also appear temporarily discolored. Keep this product warm when using in a cold region. Performance of the liquid crystal display may deteriorate in low temperatures, but will be restored when this product is returned to normal temperatures.
- **The latest high precision technology has gone into the making of the liquid crystal display of this product, but there are some pixels which are permanently lit or which do not light at all. These pixels do not affect the recorded photo. Also, depending on the angle at which the screen is viewed, the colors and brightness may appear uneven. This is due to the structure of the liquid crystal display and is not a malfunction.**

Precautions when handling the cradle



Danger

- **Do not expose the cradle to water.** Using it when wet or in a humid area (such as a bathroom) may cause fire, overheating or electric shock.
- **Never modify or disassemble the cradle.** This may cause fire, overheating, electric shock or injury.



Warning

- **Do not put metal objects on the cradle.** This may cause fire, overheating or electric shock.
- **Keep out of the reach of children.** Do not let children use this product without adult supervision.

 **Caution**

- Be sure to charge batteries within the temperature range of 5 °C - 35 °C/41 °F - 95 °F. If not, explosion, fire, battery leakage or other damage may result.
- Do not put anything heavy on the cradle or leave it in an unstable position or in a humid place. This may cause explosion, fire, leakage, or battery malfunction.
- Do not touch the cradle for too long when using it. This may cause minor burns.
- If charging does not complete after 5 hours, there may be a malfunction. If this occurs, disconnect the power plug and consult your nearest Olympus service center.
- Do not use or store the cradle in/on an unstable place, such as a television set, etc. If it falls, it may cause injury or break.

Precautions when handling the AC adapter

 **Caution**

- Use only the supplied AC adapter or one specified by Olympus. Failure to do so may cause a safety risk or malfunction. Use the AC adapter with the specified voltage range.
- The AC adapter is for indoor use only.
- Be sure to turn off this product before you disconnect the cables from the terminals or electrical outlet. Failure to do so could cause data problems, or affect the internal settings or functions of this product.
- If you are not to use this product for long period of time, disconnect the AC adapter from the wall outlet for safety.
- Connect the AC adapter to a wall outlet properly. Allow for cord length, and do not put any force on the AC adapter or cord.
- The AC adapter may become warm while being used. This is not a malfunction.
- You may hear some signal from inside the AC adapter. This is not a malfunction.
- Use the AC adapter away from radios. Doing so may cause noise in the radio.

About the built-in hard disk

This product includes a built-in hard disk. Hard disks are sensitive to environmental conditions such as jolting, vibration, temperature, etc. Please take note of the following warnings. If this product is not used in accordance with these warnings, malfunction, damage, or loss of data may result.

- Avoid using or leaving this product for long periods of time in the following places as this could result in failure, malfunction, or loss of data.
 - Do not subject this product to rapid temperature changes which may produce condensation.
 - Avoid using during a thunderstorm.
 - Keep this product away from equipment with magnets, such as speakers.
 - Avoid placing this product in places subject to strong vibration.
 - Do not place any object on this product, and be careful not to drop anything on this product.
 - Do not place objects filled with liquid, such as cups, near this product or otherwise expose this product to liquids or places subject to high humidity.
 - Do not subject this product to strong vibration or shock, or throw/drop it.
 - Do not use excessive force when operating this product.
 - When writing or reading data to/on this product, do not turn off or remove the USB cable.
- Do not format this product from your computer.
- Stored data in the hard disk may be corrupted or erased by operating mistakes, this product malfunctioning, or during repair work. We recommend backing up all important content to other media, such as a computer hard disk.
- Please read all materials carefully, we are not responsible for damaged content saved on the built-in hard disk.
- Be sure to back up your data before sending this product for repair or service.
Writing to hard disk or deleting data may be necessary during the repair or service.

Information regarding the built-in battery

The built-in battery is exclusively for use with the HDD Motion Music Player m:robe MR-500i. Never use it in other equipment.

• Discharging

The built-in battery self-discharges while it is not in use. Be sure to charge it regularly before use. We recommend charging the built-in battery once every 6 months to maintain its performance if it is not to be used for an extended period of time.

• Life of the built-in battery

- The built-in battery is good for about 500 complete charges and discharges, depending on usage.
- The life of the built-in battery is limited. The built-in battery's charge becomes shorter after repeated use. If the built-in battery discharges soon after charging, it may be time to replace it. Please contact your nearest Olympus service center for assistance.

• Operating temperature

Built-in batteries are chemical products. The built-in battery's efficiency may vary, even when operating within the recommended temperature range, but this is not a malfunction.

- Recommended temperature range for use
 - Charging: 5 °C - 35 °C/41 °F - 95 °F

Using this product outside the above temperature range may result in reduced efficiency and shorter life of the built-in battery.



Tip

This charger is designed to fully charge the built-in batteries regardless of their energy level.

(NL) Batterij niet weggooien, maar inleveren als KCA.



For customers in Germany

Olympus has a contract with the GRS (Joint Battery Disposal Association) in Germany to ensure environmentally friendly disposal.

• Disposal

This product has a built-in lithium-polymer battery. Lithium-polymer batteries are recyclable. When you dispose of this product, return the built-in battery to the recycling location. For details on removing the built-in battery, refer to "Notes when you dispose of your m:robe" (📖 page 104).

Never disassemble this product except when disposing of it.

Controls: location and function

Read this first

Device

Front

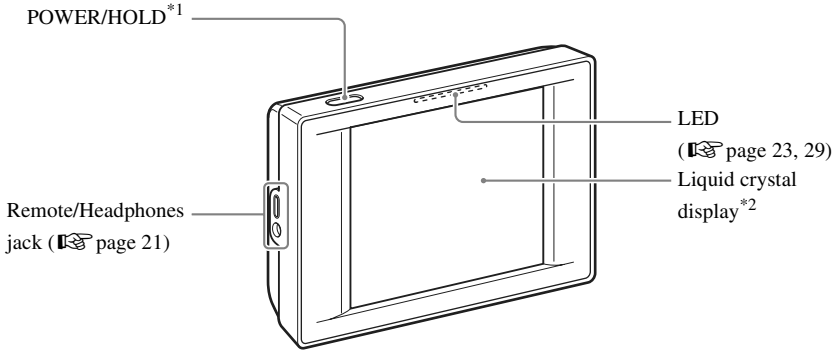

*1 Press to turn on your m:robe. Press and hold until the LED flashes to turn off your m:robe (page 27).

Press when your m:robe is turned on to toggle HOLD on or off (page 22).

*2 You can operate your m:robe by the touch panel (page 19).

Rear

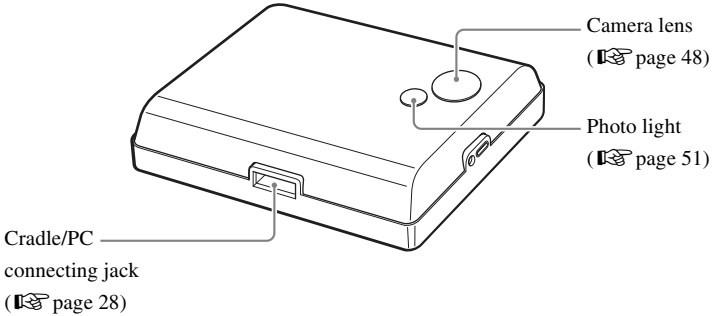

About the liquid crystal display (“HOME” screen)

The liquid crystal display is used as the touch panel.

Touch an icon displayed with your finger lightly to operate.

In bright areas, images on the screen may be difficult to see.

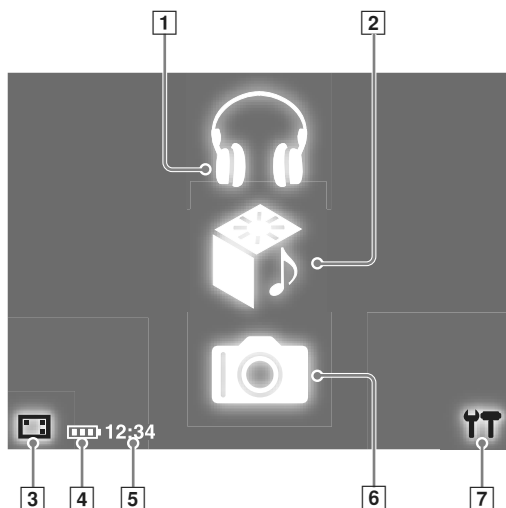

No.	Item	Explanation
1	MUSIC	Touch to display the “MUSIC” screen, where you can operate and adjust the settings for music playback (🔊 page 32).
2	REMIX	Touch to display the “REMIX” screen, where you can combine music and photos with remix effects (🔊 page 67).
3	Display on/off	Touch to hide/display the corner icons, and the indicators at the bottom of the screen.
4	Battery indicator	Indicates remaining battery.
5	Current time	The current time is displayed. For details on setting the time, refer to “Setting the date and time” (🕒 page 97).
6	PHOTO	Touch to display the “PHOTO” screen, where you can perform operations and adjust settings for shooting, viewing photos, etc. (📷 page 46).
7	Settings	Touch to display the “m:robe SETTINGS” screen, where you can set the display language, date and time, etc. (🔧 page 96).

About the remaining battery indication

Battery indicator	Explanation
	The battery is fully charged.
	Low battery.
	The battery is empty. Charge the battery.

Remote

You can control certain music functions with the remote.

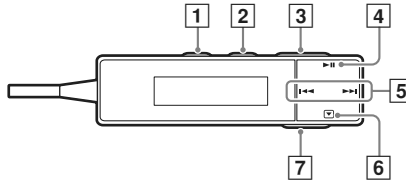

No.	Item	Explanation
1	Add to FAVORITES	Press and hold to add the currently displayed track to the “FAVORITES” list (page 45).
2	MODE	Press repeatedly to select the desired playback mode. Each press switches the mode as follows: REPEAT ALL/REPEAT ONE/RANDOM/RANDOM REPEAT/OFF.
3	Volume +/-	Adjust the volume by pressing + or -.
4	Play/Stop	Play/Stop the playback.
5	Previous track (rewind) /Next track (fast-forward)	Press to return to the beginning of the current track. Press twice to return to the beginning of the previous track. Press and hold to rewind. Press to play back the next track. Press and hold to fast-forward.
6	Display	Press repeatedly to change the display. Each press switches the display as follows: track name/artist name/normal display.
7	HOLD	Slide the switch to set the HOLD function to ON or OFF (page 22).

Connecting the remote and headphones

Connect the remote and headphones to the device as shown below.

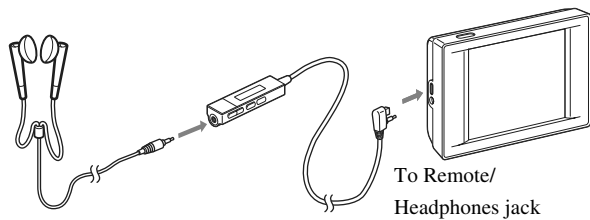

Notes

- Set the volume level to minimum before wearing headphones to avoid hurting your ears.
- Do not raise the volume excessively. Loud sounds can cause hearing loss.

● Preventing unintentional operations

Read this first

– HOLD function

This is used to prevent unintentional operations when carrying your m:robe in a pocket or a bag.

Setting the HOLD function of the device to ON

Press HOLD when the device is turned on.

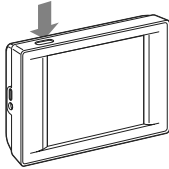

The screen disappears and the touch panel becomes inactive.

To set HOLD to OFF

Press HOLD again.



Note

If you press and hold POWER/HOLD until the LED flashes, the device is turned off. Press POWER/HOLD to turn the device on.

Setting the HOLD function of the remote to ON

Slide the HOLD switch in the direction of the arrow.

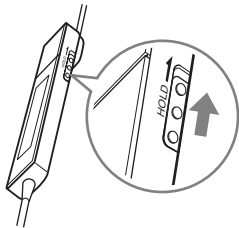

The buttons on the remote become inactive.

To set HOLD to OFF

Slide the HOLD switch in the opposite direction of the arrow.

Getting Started

● Setting up your m:robe

! Note

Do not connect your m:robe to your computer before installing the supplied Music/Photo Organization Software “m:trip.”

Charging the battery

- 1 Connect the AC cord to the AC adapter.
- 2 Connect the AC adapter to the DC IN 5V jack of the cradle.
- 3 Plug the AC cord into a wall outlet.
- 4 After checking that your m:robe is turned off, place it in its cradle.

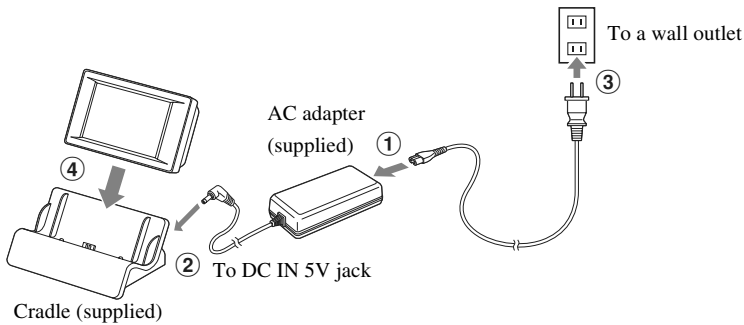

Tip

Plug shape differs depending on country.

Charging starts. The LED of the device lights up.

After charging, the LED goes off.

Tips

- The battery is fully charged in about 3 hours.
- The supplied AC adapter is designed only for Olympus products that specify 5V DC input.

● Setting up m:trip

Operating system requirements

The following systems are required for m:trip operation.

- OS: Windows 2000 Professional, Windows XP Professional/Home Edition
- CPU: Pentium III 500 MHz or later
- RAM: 128 MB or more (256 MB or more recommended)
- HD space: at least 200 MB (for installation)
- USB port: USB 2.0/1.1 (USB 2.0 (High Speed) recommended)
- Monitor: 800 × 600 dots or more, 65,536 colors or more (16,770,000 colors recommended)
- CD-ROM drive
- Internet Explorer 6 or later
- Windows Media Player 9 or later



Tip

Operation is not guaranteed with OS upgraded computers.

Installing the Music/Photo Organization Software “m:trip”

- 1 Turn on your computer and insert the supplied CD-ROM into the CD-ROM drive. The screen below appears.

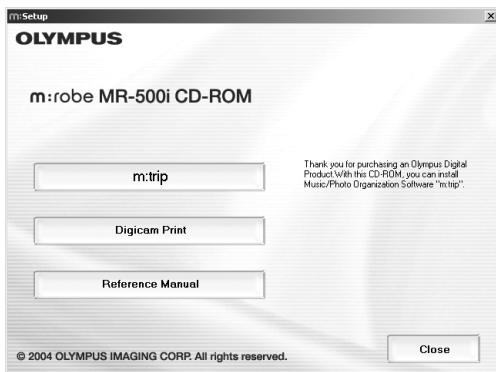

Tip

If the screen above does not appear after inserting the supplied CD-ROM, click [My Computer] on the desktop (from the Start Menu for Windows XP), double-click the CD-ROM icon and run the [Launcher.exe] file.

- 2 Click the [m:trip] button.
After the Install Wizard screen appears, follow the on-screen instructions.
- 3 Click [Finish] when the Install Wizard Complete screen appears.
Installation of m:trip is complete.
If you are prompted to reboot your computer after installation, reboot your computer.

To run m:trip

Double-click the m:trip icon on the desktop.

After running m:trip, register your m:robe in the user registration screen.

Using the online Help

For details on operations and instructions for m:trip, refer to the online Help.

To browse the online Help, click [Help] at the top of the screen.

Importing music/photos to m:trip

Importing music

You can import music from audio CDs.

When importing audio data from your audio CD, the file format will be WMA.

Files cannot be imported as MP3 files with m:trip.

- 1 Insert an audio CD into your computer.
m:trip automatically runs and the screen below appears.

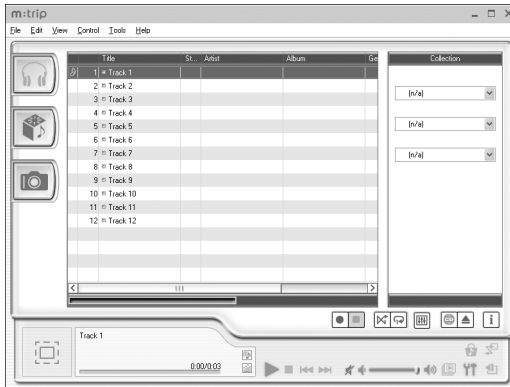

Tip

Run [m-trip] by selecting [start], [(All) Programs] and [OLYMPUS m-trip] if it does not run automatically.

- 2 Click the [Import from audio CD] button on your computer screen.
Importing of the audio CD starts.



Tips

- You can also import WMA or MP3 files already stored on your computer, or buy audio files downloaded from the Internet. For details, refer to the m:trip online Help.
- You cannot play back audio files on your m:robe that are transferred using the software other than m:trip, such as Windows Explorer. Use only m:trip to transfer audio files to your m:robe. For details, refer to the m:trip online Help.

Importing photos

Not only can you take photos and store them on your m:robe, but you can also transfer image files already stored on your computer to your m:robe. If you want to transfer the image files on your computer to your m:robe, import them to m:trip before transferring. For details on how to import the files, refer to the m:trip online Help.

● Transferring music/photos from m:trip to your m:robe

Turning on your m:robe

Press POWER.

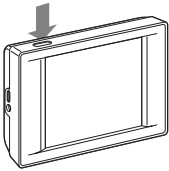

To turn off your m:robe

Press and hold POWER until the LED flashes.



Tip

If playback of music, slide show or remix is stopped and no operation is performed for more than 10 minutes, your m:robe is automatically turned off (Auto Off function). To turn on your m:robe again, press POWER.

Connecting to your computer

1 Check that “USB CONNECTION” of your m:robe is set to “PC.”

① Touch **YT** in the bottom right corner of the “HOME” screen.

The “m:robe SETTINGS” screen appears.

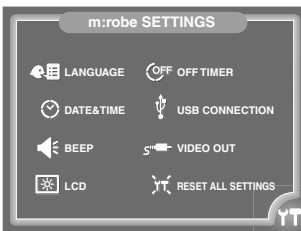

② Touch “USB CONNECTION.”

The “USB CONNECTION” screen appears.

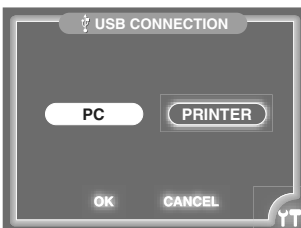

- ③ Check that “PC” is selected.
If “PC” is not selected, touch “PC.”
- ④ Touch “OK.”
The “m:robe SETTINGS” screen reappears.

To return to the “HOME” screen

Touch  in the bottom right corner of the screen.

2 Connect your m:robe to your computer.

- ① Connect the AC adapter to the cradle.
Connect the AC cord to the AC adapter, connect the AC adapter to the DC IN 5V jack, and then plug the AC cord into a wall outlet.
- ② Connect your computer and the cradle using the dedicated USB cable.
Connect the connector with the arrow marks facing down to the USB jack of the cradle.
- ③ Place your m:robe in the cradle.

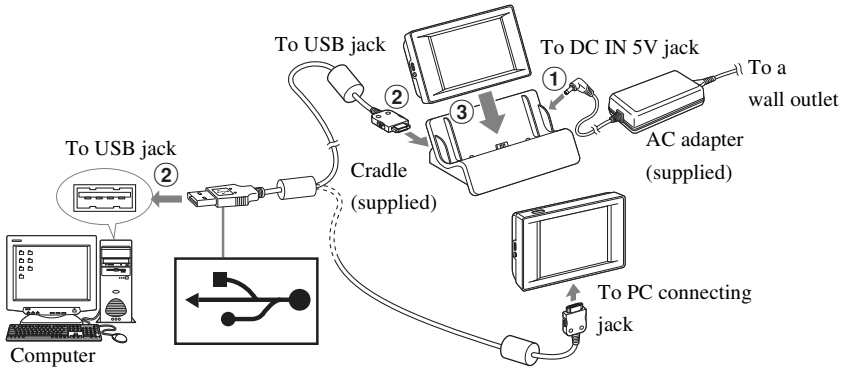

 **Tip**

You can also connect your m:robe directly to the computer as shown above. When connecting directly to the computer, check that the battery is fully charged.

 **Note**

If your m:robe stops operating while communicating with your computer, your computer may malfunction or data may be lost. We recommend using the AC adapter when connecting to your computer.

Starting transfer

After you connect your m:robe to your computer, m:trip automatically runs.

To start transferring, click the [Sync] button in the bottom right of your m:trip screen. Then, click [Start] in the display that pops up to begin transfer.

During transfer, the LED of the device flashes.

When transfer is complete, the LED goes off, and the “DO NOT DISCONNECT!” message displayed on your m:robe changes to “SYNCHRONIZATION COMPLETE IT IS SAFE TO DISCONNECT m:robe FROM YOUR PC.”



Tip

You can set m:trip not to run automatically when connecting your m:robe and your computer. For details, refer to the m:trip online Help.

Disconnecting your m:robe from your computer

- 1 Check that the “SYNCHRONIZATION COMPLETE IT IS SAFE TO DISCONNECT m:robe FROM YOUR PC” message is displayed on your m:robe.
- 2 Click the [Remove m:robe] button on the m:trip screen.
- 3 Take your m:robe out of the cradle.

When connecting your m:robe directly to the computer, disconnect the dedicated USB cable from your m:robe.

About synchronization between your m:robe and m:trip

Connecting your m:robe and your computer allows you to synchronize and transfer music/photo/remix data either way between your m:robe and m:trip. This function is called “synchronization.”

For example, information added to files on m:trip will appear in your m:robe. You can also manage the m:robe data on m:trip by setting each audio/image file to synchronize or not; check/uncheck the “Sync Checkbox” which is beside each track or on each thumbnail to set to synchronize or not.

File formats supported by m:robe

- Audio file
 - WMA (including VBR)
 - MP3 (including VBR)
- Image file
 - Exif-JPEG, JFIF-JPEG
 - Exif-TIFF, TIFF (uncompressed)
 - PNG
 - Bitmap



Tip

Files that are not supported by m:robe cannot be transferred from your computer to your m:robe.

About audio file synchronization

You can organize audio files with m:trip. If there is a file on m:trip which you do not want to transfer to your m:robe though you want to keep it on m:trip, uncheck the “Sync Checkbox” beside its track on the m:trip screen to prevent the file from synchronizing.

You can also use the “Sync Checkbox” to delete files in your m:robe. Unchecking the “Sync Checkbox” of the file you want to delete on m:trip will delete the file next time you synchronize your m:robe and m:trip

( page 45).

About image file synchronization

You can set photos taken on your m:robe or stored on m:trip not to synchronize by unchecking the “Sync Checkbox.” You can also delete them on your m:robe (📄 page 62).

If you delete image files on your m:robe, and then synchronize your m:robe and m:trip, the “Sync Checkbox” of these files will be unchecked automatically. Although these files will not be transferred back to your m:robe next time when you synchronize, they will remain on m:trip.



Tip

The number of photos in each album (“keyword” in m:trip) you can transfer from m:trip by synchronization is 250 (excluding “FAVORITES”), in the order you imported them to m:trip.

About remix data synchronization

All remix data (including audio files, image files, and remix templates that form a remix cube) is synchronized. A remix cube you do not want to keep either in your m:robe or m:trip any more can be deleted on m:trip. (Deleting a remix cube does not delete the music/image files or remix template forming the remix cube from your computer.)

For details, refer to the m:trip online Help.

For details on remix cube and remix templates, refer to “📦 REMIX” (📄 page 67).



Note

If you delete files on m:trip, these files will be also deleted automatically from your m:robe next time you synchronize.



Tips

- We recommend using m:trip for convenient use of your m:robe; using m:trip allows you to easily manage data, such as backing up. In addition, be careful not to delete data managed by m:trip.
- If you have 2 or more m:robes, you can organize the data of each m:robe with one computer. You can manage up to 8 m:robes with one computer.

However, you cannot manage one m:robe with 2 or more computers.

For details, refer to the m:trip online Help.

MUSIC



In “MUSIC,” the “PLAY” mode allows you to perform music playback operations (☞ page 32). The “SEARCH” mode narrows down your search, using categories (☞ page 40).

This chapter is an introduction to the functions of “MUSIC.”

MUSIC

To display the “MUSIC” screen

Turn on your m:robe by pressing POWER, then touch  on the “HOME” screen.

If the “PHOTO” or “REMIX” screen is displayed, touch  in the top left corner of the screen, then touch  “MUSIC.”









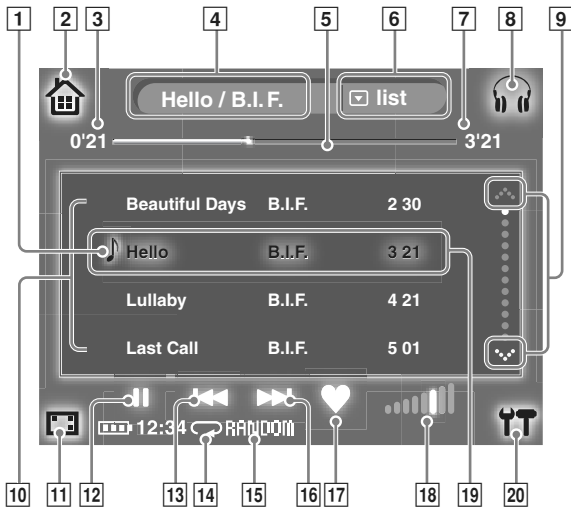

Listening to the music

– “PLAY” mode

Basic operations of music playback

Example: the “list” screen



No.	Item	Explanation
1	Currently played	Indicates the track currently/to be played.
2	“REMIX”/“PHOTO”/ “HOME” select	Touch to display the screen to select “  REMIX”/“  PHOTO”/“  HOME” and display their respective screens.
3	Elapsed time	The elapsed playback time is displayed.
4	Mode name	When selecting the “PLAY” or “SEARCH” mode, “PLAY” or “SEARCH” appears for 2 seconds.
	Track/artist name	The track/artist name currently/to be played are displayed.
5	Current playback point	Indicates the current playback point.
6	“list”/“info”/“lyrics”/ “EQ” select	Touch repeatedly to display the “list” (current screen), “info” (album information/jacket photo) ( page 36), “lyrics” (song lyrics) ( page 37), and “EQ” (equalizer) ( page 38) screens.
7	Total time	The total time of the currently played track is displayed.
8	Mode select	Touch to display the screen to select “  SEARCH” and display the “SEARCH” mode screen.
9	Backward/ Forward in track list	If there are more than 4 tracks in the track list, touching  displays the next track, and touching  displays the previous track.
10	Track list	The track list of the currently selected item (e.g. an album) is displayed.
11	Display on/off	Touch to hide/display the corner icons, and the indicators at the bottom of the screen.
12	Play/Stop	Touch  to start playback of the selected track.* Touch  to stop playback.
13	Previous track/rewind	Touch to return to the beginning of the current track. Touch twice to return to the beginning of the previous track; touch and hold to rewind.

* Touching the selected (highlighted) track in the track list also starts playback.

No.	Item	Explanation
14	REPEAT indicator	Indicates that “REPEAT” is set to “ONE” or “ALL” (👉 page 35).
15	RANDOM indicator	Indicates that “RANDOM” is set to “ON” (👉 page 35).
16	Next track/fast-forward	Touch to play back the next track; touch and hold to fast-forward.
17	Add to FAVORITES	Touch to add the track displayed at the top of the screen to the “FAVORITES” list (👉 page 45).
18	Volume adjust	Touch to display the volume adjust screen. Touch 🔊 to turn the volume up, or touch 🔇 to turn the volume down. After adjustment, touch outside the volume adjust screen to return to the previous screen.
19	Highlight	Indicates the selected track.
20	Settings	Touch to display the “PLAYBACK SETTINGS” screen, where you can set “RANDOM” or “REPEAT” (👉 page 35).

To select the desired track or album

You can search and select the track or album in the “SEARCH” mode (👉 page 40).

Playing tracks in random order/repeatedly

You can set your m:robe to play back the tracks displayed in “PLAY” mode track list in random order. You can also set to play back one track or all the tracks in the list repeatedly.

- 1 Touch **YT** in the bottom right corner of the “MUSIC” screen.
The “PLAYBACK SETTINGS” screen appears.

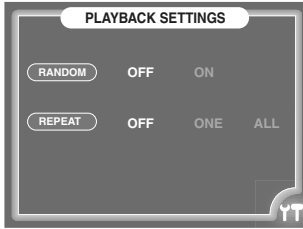

To set “RANDOM” to “ON”

- 2 Touch “ON” in “RANDOM.”

To set “REPEAT” to “ONE” or “ALL”

- 2 Touch “ONE” or “ALL” in “REPEAT.”
 - “ONE”: play back one track repeatedly.
 - “ALL”: play back all tracks in the track list repeatedly.

- 3 Touch **YT** again.

The previous screen reappears, and the setting is complete.

When “RANDOM” is set to “ON,” **RANDOM** appears; when “REPEAT” is set to “ONE,” **1** appears; when “REPEAT” is set to “ALL,” **∞** appears, at the bottom of the screen.



Tips

- To disable the setting, touch “OFF” in step 2.
- If you set “REPEAT” to “ONE,” “RANDOM” switches to “OFF.”
- With “REPEAT” set to “ONE,” if you set “RANDOM” to “ON,” “REPEAT” switches to “OFF.”
- We recommend setting the HOLD function of the device to ON when you set “RANDOM” to “ON,” or set “REPEAT” to “ONE” or “ALL” to save battery power (**🔌** page 22).

Viewing track information

– “info”

You can view the album information and jacket photo of the track displayed at the top of the screen.

To display the “info” screen

Touch  repeatedly until “info” appears beside the track/artist name at the top of the “PLAY” mode screen.

MUSIC



* When there is no jacket photo,  appears.

If the jacket photo is set using software other than m:trip,  may appear.

For details on how to obtain or set the album information and jacket photo, refer to the m:trip online Help.

Viewing lyrics

– “lyrics”

You can view the lyrics of the track displayed at the top of the screen.

To display the “lyrics” screen

Touch repeatedly until “lyrics” appears beside the track/artist name at the top of the “PLAY” mode screen.



* When there are no lyrics, “NO LYRICS” appears.

For details on how to add lyrics to a track, refer to the m:trip online Help.

Using the equalizer

– “EQ”

According to the music genre and where you are listening, you can choose one of 16 equalizer settings (excluding the “FLAT” setting). You can also customize the equalizer settings (USER SETTING).

Equalizer settings of your m:robe

For different music genres	CLASSICAL, ELECTRONICA, HIP HOP, JAZZ, POP, ROCK, R&B
For sound shaping of various frequencies	BASS BOOST, BASS CUT, MID BOOST, MID CUT, HI BOOST, HI CUT, VOCAL BOOST
Others	<p>SPOKEN WORD: This is useful for listening to voice, such as an audio book or spoken dialog.</p> <p>ON A TRAIN: This enables comfortable listening in noisy environments, such as on a train or airplane by boosting the Bass Sound. It also minimizes sound leakage (by cutting the high frequency range).</p> <p>FLAT: Equalizer flat</p> <p>USER SETTING: Customized equalizer settings</p>

- 1 Touch repeatedly until “EQ” appears beside the track/artist name at the top of the “PLAY” mode screen.

The “EQ” screen appears.



- 2 Touch the desired equalizer setting, selecting from the list in the right section of the screen using \downarrow (down) or \uparrow (up).

The equalizer is set.

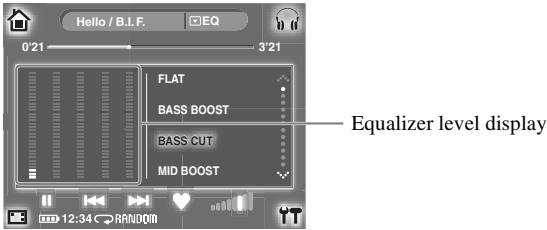

Customizing the equalizer level

- 1 Touch the equalizer level display in the left section of the screen.

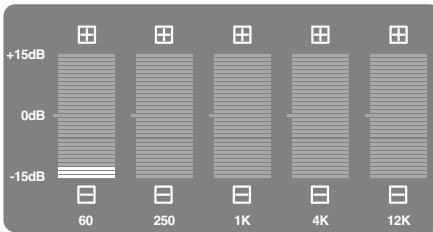

The level adjust screen appears.



- 2 Touch  to raise the level, or touch  to lower the level.

After adjustment, touch outside the level adjust screen to return to the previous screen.

“USER SETTING” in the list is highlighted, and the adjustment is registered to “USER SETTING.”

Only one setting can be registered as “USER SETTING.” Subsequent adjustment will update this setting.



Tip



Equalizer level adjustments are registered only to “USER SETTING.” Other equalizer settings are not changed.

● Searching and playing the desired track

– “SEARCH” mode

In the “SEARCH” mode, you can search for a track by a category, such as “PLAYLISTS,” “ALBUMS,” etc. You can also narrow down the search using multiple categories.

To switch the mode from “PLAY” to “SEARCH”

Touch  in the top right corner of the screen, then touch “SEARCH.”

1st level of the “SEARCH” mode screen

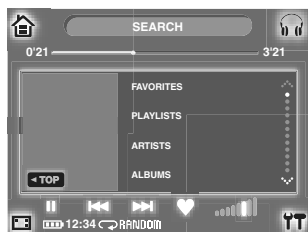

List of search categories

1st level	2nd level	3rd level	4th level	5th level	6th level
FAVORITES	List of tracks				
PLAYLISTS	List of PLAYLISTS	List of tracks			
ARTISTS	List of artists	ALBUMS ALL	List of albums List of tracks	List of tracks	
ALBUMS	List of albums	List of tracks			
GENRES	List of genres	ARTISTS ALBUMS ALL	ALBUMS List of albums List of tracks	List of albums List of tracks	List of tracks
COMPOSERS	List of composers	ALBUMS ALL	List of albums List of tracks	List of tracks	
YEAR	List of released years	ALBUMS ALL	List of albums List of tracks	List of tracks	
RECENTLY LISTENED	List of tracks				

1st level	2nd level	3rd level	4th level	5th level	6th level
TRACKS WITH PHOTOS	List of tracks				
TRACKS WITH LYRICS	List of tracks				
MY TOP 100	List of tracks				
UNPLAYED TRACKS	List of tracks				
ALL	List of tracks				

**Tip**

The list of search categories shown above differs depending on the settings on m:trip or the track information.

About “PLAYLISTS”

You can create original “PLAYLISTS” on m:trip, which can be transferred to your m:robe when synchronizing your m:robe and m:trip.

For details, refer to the m:trip online Help.

For details on synchronization, refer to “About synchronization between your m:robe and m:trip” (📖 page 30).

How to narrow down the search

Example: To narrow down the search by categories “GENRES,” “ARTISTS,” and “ALBUMS”

- 1 Touch “GENRES” in the category list of the 1st level of the “SEARCH” mode screen.
The list of genres appears.



2 Touch the desired genre in the list.



MUSIC

3 Touch "ARTISTS."
The list of artists appears.



4 Touch the desired artist in the list.



5 Touch "ALBUMS."

The list of albums appears.



6 Touch the desired album in the list.

The list of tracks of the selected album appears.



7 Touch the desired track.

The selected track is highlighted.



8 Touch the track again, or touch ►.

Playback starts, and the mode switches automatically from “SEARCH” to “PLAY.”



The tracks in the album are displayed in the track list of “PLAY” mode and played back in sequence.



Tips

- If you touch ► during the search process, all tracks in the latest selected category will be played.
- The search will be canceled if you switch to “PLAY” mode before playing back a track in step 8.
- After the mode switches automatically to the “PLAY” mode in step 8, and you switch to “SEARCH” mode again, the previous search contents are displayed. If you want to clear these contents, touch ◀TOP at the bottom left of the screen to return to the 1st level of the “SEARCH” mode screen.

About the search records

While narrowing down the search, the search records are displayed in the left section of the screen.

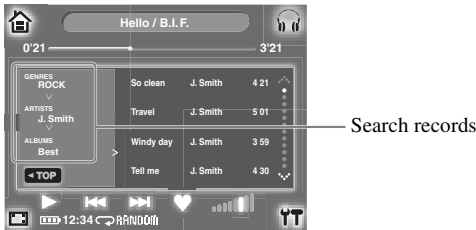

Touch the displayed items to return to the previous level screen.

For example, if you touch “GENRES/ROCK” in the screen above, the genre list screen appears.

Arranging your audio files

Deleting a track from your m:robe

If you want to delete an audio file in your m:robe, set the file not to be synchronized by unchecking the “Sync Checkbox” beside that music track on m:trip. Next time you synchronize your m:robe and m:trip, this file will not be synchronized, and will be deleted from your m:robe.

For details, refer to the m:trip online Help.

For details on synchronization, refer to “About synchronization between your m:robe and m:trip”

( page 30).

Adding a track to “FAVORITES”

You can add a track to “FAVORITES” and create a “FAVORITES” list.

Touching  adds the track displayed at the top of the “MUSIC” screen to the “FAVORITES” list, and displays the message “Added to FAVORITES.”

You can also add the track displayed on the remote to the “FAVORITES” list by simply pressing and holding  on the remote.

You can select and play back the “FAVORITES” list from the 1st level of the “SEARCH” mode screen.



If you want to remove a track from “FAVORITES,” delete the track from “FAVORITES” on m:trip, then synchronize with your m:robe. For details, refer to the m:trip online Help.

PHOTO

“PHOTO” features the “SHOOT” mode for taking a photo (☞ page 46), the “VIEW” mode to search for a photo and view (☞ page 52), and the “ALBUM” mode to add a photo to an album (☞ page 65). This chapter is an introduction to the functions of “PHOTO.”



To display the “PHOTO” screen

Turn on your m:robe by pressing POWER, then touch  on the “HOME” screen.

If the “MUSIC” or “REMIX” screen is displayed, touch  in the top left corner of the screen, then touch “PHOTO.”











Taking a photo

– “SHOOT” mode

If the “VIEW” or “ALBUM” mode screen is displayed, touch  in the top right corner of the screen, then touch “SHOOT” to switch the mode.



Basic operations of the “SHOOT” mode





No.	Item	Explanation
1	“MUSIC”/“REMIX”/ “HOME” select	Touch to display the screen to select “  MUSIC”/“  REMIX”/ “  HOME” and display their respective screens.
2	Mode select	Touch to display the screen to select “  VIEW”/“  ALBUM” and display their respective mode screens.
3	Display on/off	Touch to hide/display the corner icons, and the indicators at the bottom of the screen.
4	Image size	Indicates the currently selected image size ( page 50).
5	Album name	Indicates the currently selected album name to store ( page 49).
6	Photo light ON	Indicates that “PHOTO LIGHT” is set to “ON” ( page 51).
7	Liquid crystal display	Shooting image is displayed through the camera lens.
8	Settings	Touch to display the “PHOTO SHOOT SETTTINGS” screen, where you can set the album to store photos ( page 49), image size ( page 50) and photo light ( page 51).

Shooting photos

1 Switch to the “SHOOT” mode.

If the “MUSIC” or “REMIX” screen is displayed, touch  in the top left corner of the screen, then touch “ PHOTO.”

If the “VIEW” or “ALBUM” mode screen of “PHOTO” is displayed, touch  in the top right corner of the screen, then touch “ SHOOT” to switch the mode.

The shooting image through the camera lens appears on the screen.

PHOTO

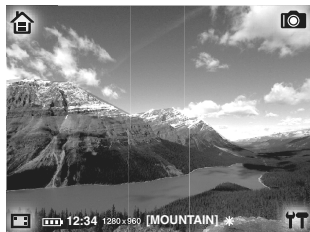

2 Compose your image while viewing the screen.

3 Touch the screen to shoot.

Hold your m:robe firmly and touch the center of the screen lightly to avoid blur.



Note

Be careful that your finger does not cover the lens.

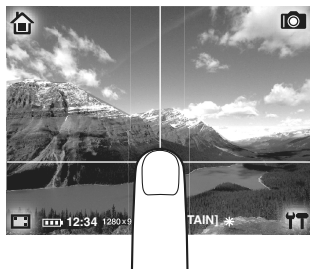

The photo just taken remains on the screen for a moment, then the image through the camera lens reappears.



Tip

If no operation is performed for about 1 minute in the “SHOOT” mode, the screen switches to “HOME” automatically.

To view photos you have taken

You can view photos you have taken in the “VIEW” mode ( page 52).

Setting the album to store captured photos

You can set an album created on your m:robe or m:trip to which you can store new photos.

You can also add photos which you have taken to albums in the “ALBUM” mode (📖 page 65).

1 Touch **TT** in the bottom right corner of the “SHOOT” mode screen.

The “PHOTO SHOOT SETTINGS” screen appears.

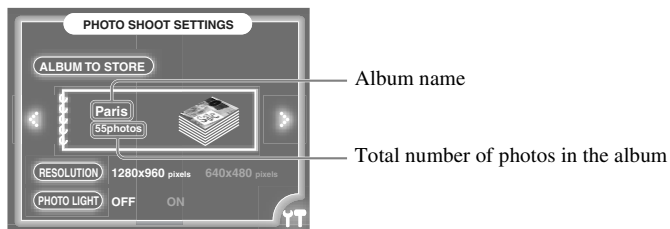

Album name

Total number of photos in the album

2 Display the album to which you want to store the photo using ⋮ (next) or ⋮ (previous).

To create a new album in your m:robe, select “NEW.”

3 Touch **TT** again.

The previous screen reappears, and the setting is complete.

The selected album name will be displayed at the bottom of the screen.



Tips

- In each album (excluding “FAVORITES”), you can store up to 250 photos. When the number of photos in the selected album goes beyond this limitation, the setting of “ALBUM TO STORE” switches to “NOT STORE IN ALBUM.”
- The next photo you take will be stored in the previously selected album. Before shooting, check which album has been set to store photos.
- “FAVORITES” is included in the setting items in “ALBUM TO STORE.” Display “FAVORITES” in step 2 to store photos to “FAVORITES.” You can view the “FAVORITES” album from the search method “album” screen in the “VIEW” mode (📖 page 56).

To not to store images in any album

Select “NOT STORE IN ALBUM” in step 2.

To change the name of a newly created album

If you create albums with your m:robe, the album names will be “NEW1,” “NEW2,” and so on.

You can change the album name on m:trip. Changing the “keyword” registered to the image file (in this case the “keyword” is “NEW1”) on m:trip will update the album name on your m:robe next time you synchronize your m:robe and m:trip. For details on synchronization, refer to “About synchronization between your m:robe and m:trip” (📖 page 30).

Setting image size

Image size can be set to “1280×960 pixels” or “640×480 pixels.”

- **“1280×960 pixels”**: width 1280 × height 960 pixels
This size is suitable for displaying on the computer or printing.
- **“640×480 pixels”**: width 640 × height 480 pixels
This size is suitable for displaying on the computer.

- 1 Touch **TT** in the bottom right corner of the “SHOOT” mode screen.
The “PHOTO SHOOT SETTINGS” screen appears.

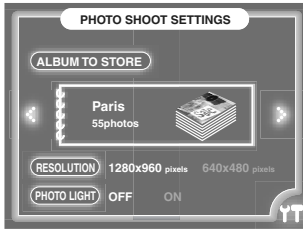

- 2 Touch “1280×960 pixels” or “640×480 pixels” in “RESOLUTION.”
- 3 Touch **TT** again.

The previous screen reappears, and the setting is complete.
The selected image size is displayed at the bottom of the screen.

Setting the photo light

The photo light can be used when taking photos in a dark place.

- **OFF**

Photo light turned off.

- **ON**

Always on in the “SHOOT” mode of “PHOTO.”

- 1 Touch **YT** in the bottom right corner of the “SHOOT” mode screen.
The “PHOTO SHOOT SETTINGS” screen appears.



- 2 Touch “OFF” or “ON” in “PHOTO LIGHT.”

- 3 Touch **YT** again.

The previous screen reappears, and the setting is complete.

* is displayed at the bottom of the screen when you select “ON” in step 2.



Tip

The photo light helps when taking photos in a dark place, but does not have the same effect as a regular camera flash.

● Viewing/searching for a photo

– “VIEW” mode

In the “VIEW” mode, you can view a photo taken on your m:robe, or a photo transferred from m:trip by synchronizing. You can search for a photo using one of the following 3 methods:

“all” (📷 page 54) -search by thumbnails of all photos in your m:robe.

“album” (📷 page 56) -search by album.

“calendar” (📷 page 57) -search by shooting date.

If the “SHOOT” or “ALBUM” mode screen is displayed, touch 📷 in the top right corner of the screen, then touch ▶️ VIEW to switch the mode.

PHOTO

Basic operations of the “VIEW” mode

Example: the search method “all” screen



No.	Item	Explanation
1	“MUSIC”/“REMIX”/ “HOME” select	Touch to display the screen to select “ MUSIC”/“ REMIX”/ “ HOME” and display their respective screens.
2	Highlight	Indicates the selected photo.
3	Mode name	The current mode name “VIEW” is displayed.
4	Search method select	Touch repeatedly to select the search method “all” (page 54), “album” (page 56) or “calendar” (page 57).
5	Current position in the list*	Indicates the approximate current position in the list.
6	Mode select	Touch to display the screen to select “ SHOOT”/“ ALBUM” and display their respective mode screens.
7	Previous item	Touch to display the previous item. Touch and hold to step back rapidly.
8	Display on/off	Touch to hide/display the corner icons, and the indicators at the bottom of the screen.
9	Slide show	Touch to start a slide show from the selected photo (page 59).
10	Print	Touch to print photos (page 80).
11	Trash bin	Touch to remove a photo from an album (page 60), or delete a photo from your m:robe (page 62).
12	Settings	Touch to display the “PHOTO VIEW SETTINGS” screen, where you can adjust the transition interval of the slide show (page 59).
13	Next item	Touch to display the next item. Touch and hold to step forward rapidly.

* Only when the search method “all” or “album” is selected.



Searching by thumbnails of all photos in your m:robe

– Search method “all”

- 1 If the search method “all” screen is not displayed, touch  repeatedly until “all” appears at the top right of the screen.



Thumbnail list

- 2 Touch a photo, selecting from the thumbnail list using  (next) or  (previous). The selected photo is highlighted.



3 Touch the photo again.



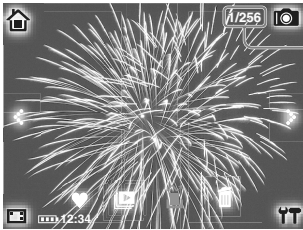

The selected photo is displayed in full screen.



Current photo/total number of photos



Tips

- The current position (current photo/total number of photos) is displayed on the screen.
- Touch  to display the next photo. Touch  to display the previous photo.
- Touching  adds the photo to "FAVORITES" ( page 64).

To return to the thumbnail list screen

Touch outside the region of the operation icons.

Searching by album

– Search method “album”

On the search method “album” screen, only the photos in albums and “FAVORITES” are displayed. You can add a photo to an album or “FAVORITES” by doing one of the following:

- Set an album to store newly-captured photos (📷 page 49).
- Add a photo to an album in the “ALBUM” mode (📷 page 65).
- Add a photo to “FAVORITES” (📷 page 64).

1 If the search method “album” screen is not displayed, touch  repeatedly until “album” appears at the top right of the screen.

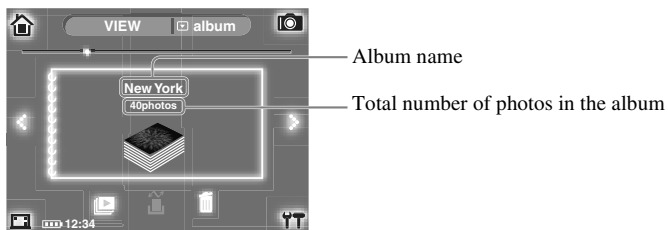

Tip



You can also display “FAVORITES” on the screen shown above.

2 Select the album using  (next) or  (previous) and touch it.

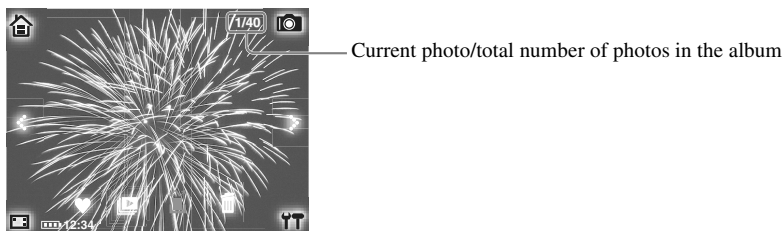
The photo in the selected album is displayed in full screen.



Tips

- The current position (current photo/ total number of photos in the album) is displayed on the screen.
- Touch  to display the next photo. Touch  to display the previous photo.
- Touching  adds the photo to “FAVORITES” (📷 page 64).

To return to the album selection screen

Touch outside the region of the operation icons.



Searching by shooting date

– Search method “calendar”

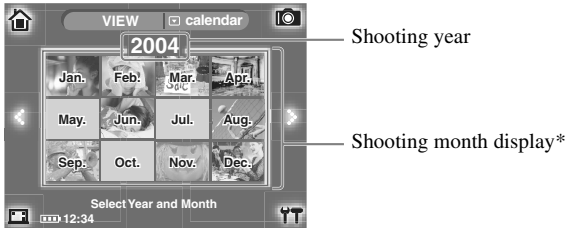
- 1 If the search method “calendar” screen is not displayed, touch  repeatedly until “calendar” appears at the top right of the screen.



* If there are no photos in a month, a thumbnail image is not displayed.

- 2 Select the shooting year using  (next) or  (previous), and touch the shooting month.

The photos in the selected month are displayed in order of date. A date containing no photos will not be displayed.

Touch  when you want to return to the year/month selecting screen.

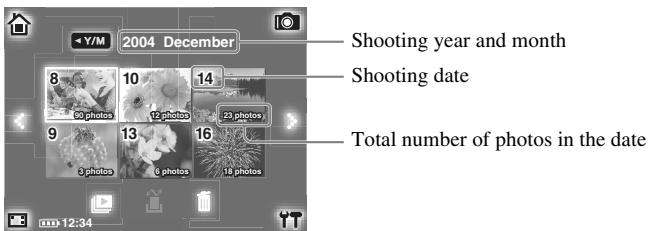

3 Touch the date, selecting from the list using ⋮ (next) or ⋮ (previous).

The photo in the selected date is highlighted.



4 Touch the photo.

The selected photo is displayed in full screen.

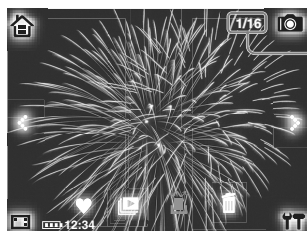

Current photo/total number of photos in the date





Tips

- The current position (current photo/total number of photos in the date) is displayed on the screen.
- Touch ⋮ to display the next photo. Touch ⋮ to display the previous photo.
- Touching ♥ adds the photo to “FAVORITES” (👉 page 64).

To return to the shooting date selection screen

Touch outside the region of the operation icons.

Slide show

You can view photos in a slide show when  is displayed at the bottom of the screen in the “VIEW” mode. After selecting a photo or an item such as an album, date, etc., touch . The slide show begins from the selected photo or the first photo of the selected item. You can also change the slide show interval.

Setting the slide show interval



Tip

The default setting of the slide show interval is set to “1sec.”

- 1 Touch  in the bottom right corner of the “VIEW” mode screen. The “PHOTO VIEW SETTINGS” screen appears.

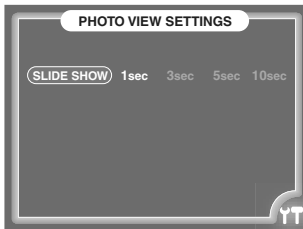

- 2 Touch “1sec,” “3sec,” “5sec” or “10sec.”
- 3 Touch  again. The previous screen reappears, and the setting is complete.

To stop the slide show

Touch the screen.

Removing photos from albums

On the search method “album” screen, you can remove photos from albums.

Photos removed from albums remain on your m:robe.

Removing all photos from an album

- 1 Display the album you want to remove on the search method “album” screen.
- 2 Touch  at the bottom of the screen.
“Remove from album” and “Delete from album” appear on the screen.
- 3 Touch “Remove from album.”



Tip

Touching “Delete from album” will delete all photos in the album from your m:robe ( page 62).

- 4 Touch “OK” on the “This will remove all photos from this album” message screen.
- 5 Touch “OK” again on the “Are you sure?” message screen.
All photos in the album are removed, and the total number of photos in the album becomes “0.”



Tips

- You can also remove all photos from “FAVORITES” by following the steps above, except:
Step 1: display “FAVORITES.”
Step 3: touch “Remove from FAVORITES.”
Step 4: touch “OK” on the “This will remove all photos from FAVORITES” message screen.
- To cancel, touch “CANCEL” in step 4 or 5.

Removing a single photo from an album

- 1 Display the photo you want to remove in full screen from the search method “album” screen.
- 2 Touch  at the bottom of the screen.
“Remove photo from album” and “Delete photo” appear on the screen.
- 3 Touch “Remove photo from album.”



Tip

Touching “Delete photo” will delete the photo from your m:robe ( page 63).

- 4 Touch “OK” on the “This will remove this photo from this album” message screen.
- 5 Touch “OK” again on the “Are you sure?” message screen.
The photo is removed from the album, and the total number of photos in the album is updated.



Tips

- You can also remove a photo from “FAVORITES” by following the steps above, except:
Step 1: display the photo in full screen from “FAVORITES.”
Step 3: touch “Remove photo from FAVORITES.”
Step 4: touch “OK” on the “This will remove this photo from FAVORITES” message screen.
- To cancel, touch “CANCEL” in step 4 or 5.

Deleting photos from your m:robe

You can delete photos from your m:robe when  is displayed at the bottom of the screen in the “VIEW” mode. If you delete the image files on your m:robe, and then synchronize your m:robe and m:trip, the “Sync Checkbox” of these files will be unchecked automatically. Although these files will not be transferred back to your m:robe next time when you synchronize, they will remain on m:trip.

For details on synchronization, refer to “About synchronization between your m:robe and m:trip” ( page 30).

Deleting all photos in an album

You can delete all photos in an album from your m:robe.

- 1 Display the album you want to delete on the search method “album” screen.
- 2 Touch  at the bottom of the screen.
“Remove from album” and “Delete from album” appear on the screen.
- 3 Touch “Delete from album.”



Tip

Touching “Remove from album” will remove all photos in the album ( page 60).

- 4 Touch “OK” on the “This will delete all photos in this album from m:robe” message screen.
- 5 Touch “OK” again on the “Are you sure?” message screen.
All photos in the album are deleted, and the total number of photos in the album becomes “0.”



Tips

- You can also delete all photos from “FAVORITES” by following the steps above, except:
Step 1: display “FAVORITES.”
Step 3: touch “Delete from FAVORITES.”
Step 4: touch “OK” on the “This will delete all photos in FAVORITES from m:robe” message screen.
- To cancel, touch “CANCEL” in step 4 or 5.

Deleting all photos in a shooting date

You can delete all photos in a shooting date from your m:robe.

- 1 Touch the shooting date you want to delete on the shooting date selecting screen of the search method “calendar.”
- 2 Touch  at the bottom of the screen.
- 3 Touch “OK” on the “This will delete all photos from this day from m:robe” message screen.
- 4 Touch “OK” again on the “Are you sure?” message screen.
All photos in the selected date are deleted.



Tip

To cancel, touch “CANCEL” in step 3 or 4.

Deleting a photo one by one

You can delete a highlighted photo on the search method “all” screen or a photo displayed in full screen from your m:robe.

- 1 Touch to select a photo you want to delete from the thumbnail list on the search method “all” screen. Or display a photo in full screen from the search method “all,” “album” or “calendar” screen.
- 2 Touch  at the bottom of the screen.
If you display the photo in full screen from the search method “album” screen, “Remove photo from album” (if you display from “FAVORITES,” “Remove photo from FAVORITES”) and “Delete photo” appear on the screen. Touch “Delete photo.”
- 3 Touch “OK” on the “This will delete this photo from m:robe” message screen.
- 4 Touch “OK” again on the “Are you sure?” message screen.
The photo is deleted.



Tip

To cancel, touch “CANCEL” in step 3 or 4.

Adding a photo to “FAVORITES”

You can add a photo to “FAVORITES” and create a “FAVORITES” album.

Touching  adds the photo displayed in full screen to the “FAVORITES” album, and displays the message “Added to FAVORITES.”

You can view the “FAVORITES” album from the search method “album” screen in the “VIEW” mode.

You can also remove a photo(s) from “FAVORITES,” or delete a photo(s) in “FAVORITES” from your m:robe.

Follow the procedure to remove a photo(s) from an album when removing from “FAVORITES.”

For details, refer to “Removing photos from albums” ( page 60).



Follow the procedure to delete a photo(s) from an album when deleting from “FAVORITES.”



For details, refer to “Deleting photos from your m:robe” ( page 62).

● Adding a photo to an album

– “ALBUM” mode

In the “ALBUM” mode, you can add a photo to an album stored on your m:robe.

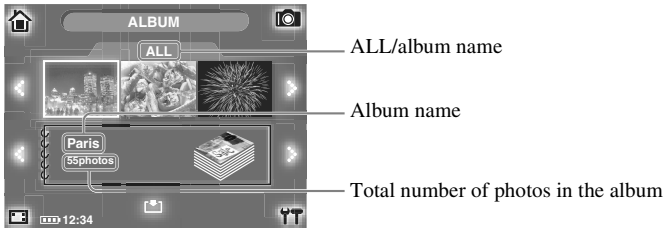

If the “SHOOT” or “VIEW” mode screen is displayed, touch  in the top right corner of the screen, then touch  “ALBUM” to switch the mode.

- 1 Display the album to add the photo to in the lower section of the screen, using  (next) or  (previous).



Tips

- In each album (excluding “FAVORITES”), you can store up to 250 photos. When the number of photos in the selected album goes beyond this limitation, you cannot add photos to it.
- You can also display “FAVORITES” in the lower section of the screen shown above.

- 2 Touch the photo you want to add to the album, selecting from the thumbnail list in the upper section of the screen, using  (next) or  (previous).

- 3 Touch  at the bottom of the screen.

The photo is added to the album, and the total number of photos in the album is updated.



Tip

If the added photo is already in the album, the total number of photos in the album will not be updated.

Changing the contents of the thumbnail list

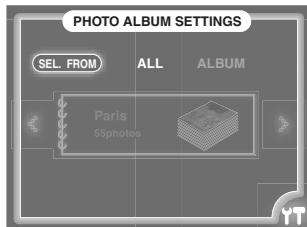

You can change the thumbnail list displayed in the upper section of the screen to show photos in a desired album.

- 1 Touch  in the bottom right corner of the “ALBUM” mode screen.
The “PHOTO ALBUM SETTINGS” screen appears.

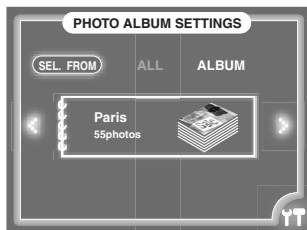

- 2 Touch “ALBUM” in “SEL. FROM.”



- 3 Display the album using  (next) or  (previous).
- 4 Touch  again.
The “ALBUM” mode screen reappears, and the setting is complete.

 **Tips**

- If you want to display the thumbnail list of all photos in your m:robe again, touch “ALL” in “SEL. FROM” in step 2.
- You can also display “FAVORITES” in step 3.





In “REMIX,” you can create your own original REMIX ‘montage’ with a combination of a song, photos and a remix template, which we call a “remix cube.” “REMIX” features “SET” mode for creating a remix cube, and “PLAY” mode for playing back a remix cube.

This chapter is an introduction to the functions of “REMIX.”

To display the “REMIX” screen

Turn on your m:robe by pressing POWER, then touch  on the “HOME” screen.

If the “MUSIC” or “PHOTO” screen is displayed, touch  in the top left corner of the screen, then touch  REMIX.”

Creating a remix cube

– “SET” mode

What is a remix cube?

A remix cube is a combination of a song, photos and a remix template, which you can select and then save. The remix cube is displayed as a cube icon attached with the name of the selected song, photos and template.

What is a remix template?

A remix template adds cinematic effects, such as motion (panning, crossfade, etc.) and creative superimposition to a series of images. Each template has a name such as “geometric,” that represents the visual effect.





Preset remix templates in your m:robe

Various templates are available to use on your m:robe. Some of them are shown in the list below.



Tips

- There is a limitation on the number of photos you can use for a remix cube. This number differs depending on the template.
- Animation applied to a remix template may appear differently depending on your computer environment.
- Depending on the template, its appearance may differ on your m:robe and the computer, in order to make it suitable for playback on m:robe.

Remix template	Explanation
flash back 	Creates 'memory flashback' imagery using sparkling, photo overlap effects.
tiles 	Features metamorphic framing effects. Switches screens one after the other with multiple photos sliding in horizontally and vertically.
geometric 	Provides visual effects, such as screen switching, with interweaving geometric patterns (borders, dots, waves, etc.).
Birthday 	Features a pop visual effect with a "Happy Birthday" message and rapid screen switching, suitable for up-tempo music.

REMIX

Basic operations of the "SET" mode

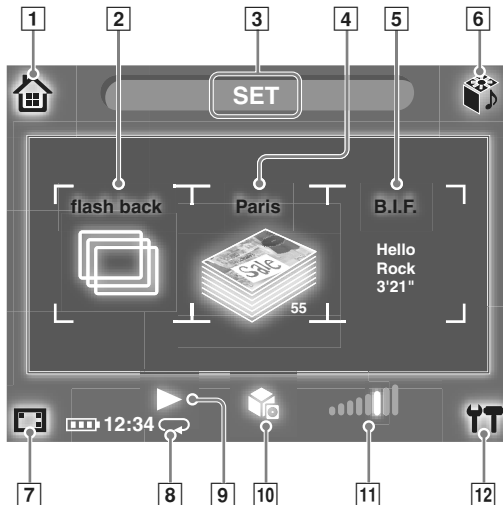

No.	Item	Explanation
1	“MUSIC”/“PHOTO”/“HOME” select	Touch to display the screen to select “MUSIC”/“PHOTO”/“HOME” and display their respective screens.
2	Template icon	Touch to display the “-TEMPLATE-” screen, where you select the template (page 71).
3	Mode name	The current mode name “SET” is displayed.
4	Album icon	Touch to display the “-PHOTO-” screen, where you select the album (page 72).
5	Song icon	Touch to display the “-MUSIC-” screen, where you select the song (page 73).
6	Mode select	Touch to display the screen to select “PLAY” and display the “PLAY” mode screen.
7	Display on/off	Touch to hide/display the corner icons, and the indicators at the bottom of the screen.
8	REPEAT indicator	Indicates that “REPEAT” is set to “ONE” or “ALL” (page 79).
9	Preview	Touch to start preview playback (page 75).
10	SAVE	Saves the remix cube (page 75).
11	Volume adjust	Touch to display the volume adjust screen. Touch to turn the volume up, or touch to turn the volume down. After adjustment, touch outside the volume adjust screen to return to the previous screen.
12	Settings	Touch to display the “REMIX SETTINGS” screen, where you can set “REPEAT” (page 79), “PHOTO SEL.” (page 74) or “AUTO SET” (page 70).

How to create a remix cube

There are two ways to create a remix cube: using either the “AUTO SET” feature, or the default (AUTO SET-OFF).

- **AUTO SET-OFF** (👁️ page 71)

You can create a remix cube with your own selection by setting a song, photos and a template.

You can create a remix cube selecting a song from the “FAVORITES” list, and an album in your m:robe for photos.

- **AUTO SET-ON** (👁️ page 76)

You can create a remix cube with the song currently playing in “MUSIC,” or the photos currently displayed in the “VIEW” mode of “PHOTO.”

This function is convenient should you be suddenly inspired by either the music or the photos.

- Switching the “MUSIC” screen to the “REMIX” screen allows you to create a remix cube using the song currently playing. Photos and a template are selected automatically.
- Switching the search method “album” screen of the “VIEW” mode in “PHOTO” to “REMIX” screen allows you to create a remix cube using the album which has been displayed. A song and a template are selected automatically.

To set “AUTO SET”

- 1 Touch **YT** in the bottom right corner of the “REMIX” screen.

The “REMIX SETTINGS” screen appears.

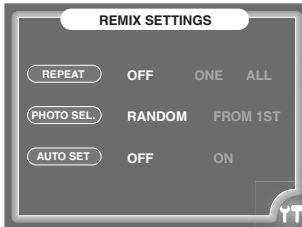

- 2 Touch “OFF” or “ON” in “AUTO SET.”

- 3 Touch **YT** again.

The previous screen reappears, and the setting is complete.

Creating your own selection (AUTO SET-OFF)

You can create a remix cube by setting a song, photos and a template.

Check whether “AUTO-SET” is set to “OFF” following the procedure “To set “AUTO SET”” (📖 page 70).

1 Select a song, photos and a template.

You can select from the desired item.

• Selecting a template

- ① Touch the template icon on the left of the “SET” mode screen to display the template selection screen.

The “-TEMPLATE-” screen appears.

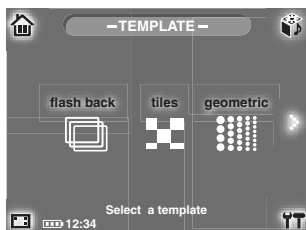

- ② Touch a template, selecting from the list using ⏪ (next) or ⏩ (previous).

The “SET” mode screen reappears, and the template is set.

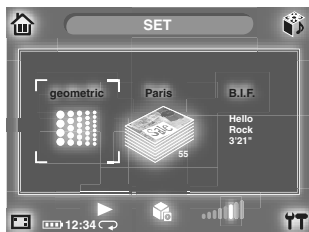

Tip

If the remix cube has not been saved, you can reselect the template already set.

• **Selecting photos**

Select a photo album.



- ① Touch the album icon in the middle of the “SET” mode screen to display the photo selection screen. The “-PHOTO-” screen appears.

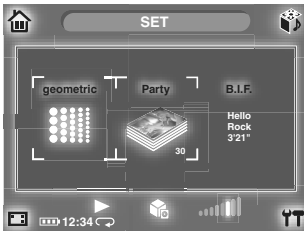

- ② Touch an album, selecting from the list using ⋮ (next) or ⋮ (previous). The “SET” mode screen reappears, and the album is set.



 **Tips**

- Only photos in albums (including “FAVORITES”) are displayed on the list in step ①. You can add a photo to an album or “FAVORITES” by doing one of the following:
 - Set an album to store newly-captured photos ( page 49).
 - Add a photo to an album in the “ALBUM” mode ( page 65).
 - Add a photo to “FAVORITES” ( page 64).
- If the remix cube has not been saved, you can reselect the album already set.
- A photo in an album with an aspect ratio other than 3:4, or one processed on the computer may be displayed rotated 90 degrees, or stretched horizontally or vertically during remix cube playback.

• Selecting a song

- ① Touch the song icon on the right of the “SET” mode screen to display the song selection screen. The “-MUSIC-” screen appears.



- ② Touch a song, selecting from the list using ⏮ (next) or ⏭ (previous). The “SET” mode screen reappears, and the song is set.

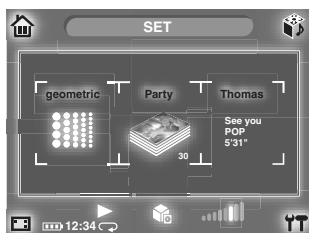

Tips

- Only the songs (tracks) added in “FAVORITES” are displayed on the list in step ①. For details on how to add a song (track) to “FAVORITES,” refer to “Adding a track to “FAVORITES”” (📖 page 45).
- If the remix cube has not been saved, you can reselect the song already set.

2 Set the photo selection method.

There is a limitation on the number of photos you can use for a remix cube playback. You can set to select photos from an album randomly, or from the first photo in the album.



Tips

- The default setting is set to “RANDOM.”
- The limitation on the number of photos differs depending on the template.
- If the number of photos in the album is less than the limitation, some photos are used repeatedly.

- ① Touch  in the bottom right of the “REMIX” screen.

The “REMIX SETTINGS” screen appears.

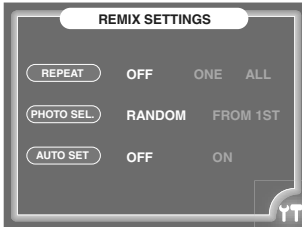

- ② Touch “RANDOM” or “FROM 1ST” in “PHOTO SEL.”

- ③ Touch  again.

The previous screen reappears, and the setting is complete.

3 Save the remix cube.

Touch  at the bottom of the screen, then touch “OK” in the displayed “SAVE” message screen.

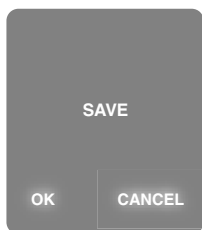

The “SAVING” screen is displayed, and the remix cube is saved. The mode switches automatically from “SET” to “PLAY.” For details on how to play back a remix cube, refer to “Playing a remix cube” ( page 78).



Tip

To cancel the save operation, touch “CANCEL.”





To play the remix cube before saving (Preview playback)

You can preview the remix cube before saving it in step 3. After step 1 or 2, touch  at the bottom of the screen to start the preview playback. Adjust the volume using the remote during the playback.

After the preview playback is over, the “SET” mode screen reappears.

Touch the screen to stop the preview playback.

To continue creating a remix cube

Touch  in the top right corner of the screen, touch “××SET” to switch to the “SET” mode, and then repeat steps 1 to 3.

Creating a remix cube with the song currently playing or photos currently displayed (AUTO SET-ON)

You can create a remix cube with the song currently playing in “MUSIC,” or the photos currently displayed in the “VIEW” mode of “PHOTO.”

- Switching the “MUSIC” screen to the “REMIX” screen allows you to create a remix cube using the song currently playing. The photos and a template are selected automatically.
- Switching the search method “album” screen of the “VIEW” mode in “PHOTO” to “REMIX” screen allows you to create a remix cube using the album which has been displayed. The song and a template are selected automatically.

Check whether “AUTO-SET” is set to “ON” following the procedure “To set “AUTO SET”” (👉 page 70).

Creating with the song currently playing (“MUSIC” to “REMIX”)



Tips

- If you switch the “MUSIC” screen to the “REMIX” screen while the music playback is stopped, the remix cube will be created by the song (track) displayed at the top of the “MUSIC” screen.
- If the song currently playing (the song displayed at the top of the “MUSIC” screen) is not added to “FAVORITES,” the song will be added to “FAVORITES” automatically after switching to the “REMIX” screen.

Switch to the “REMIX” screen while playing back the song in “MUSIC.”

Touch  in the top left corner of the “MUSIC” screen, then touch “ REMIX.”

The “SET” mode screen appears.



The name of the song currently playing (on the right of the screen), the album name (middle) and the template name (left) which are selected automatically are displayed on each icon.



Tip

You can change an album or template that has been selected automatically. Follow the procedure for creating the remix cube with your own selection. For details, refer to “Creating your own selection (AUTO SET-OFF)” (👉 page 71).

To set the photo selection, or to save the remix cube, follow the steps from step 2 on page 74.

**Creating with photos in the album currently displayed
(The search method “album” screen in the “VIEW” mode of “PHOTO” to “REMIX”)**

Switch to the “REMIX” screen while displaying an album with the search method “album” screen in the “VIEW” mode of “PHOTO.”

Touch  in the top left corner of the “PHOTO” screen, then touch  “REMIX.”

The “SET” mode screen appears.

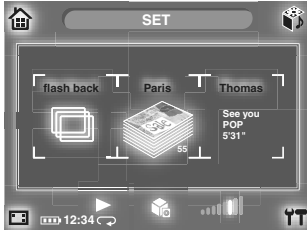

The name of the album which has been displayed (in the middle of the screen), the song name (right) and the template name (left) which are selected automatically are displayed on each icon.



Tips

- You can change a song or template that has been selected automatically. Follow the procedure for creating the remix cube with your own selection. For details, refer to “Creating your own selection (AUTO SET-OFF)” ( page 71).
- When switching the search method “all” screen in the “VIEW” mode of “PHOTO” to the “REMIX” screen, the photos to be used are selected from all the photos in your m:robe. When switching the year/month selecting screen of the search method “calendar” screen to the “REMIX” screen, the photos to be used are selected from the ones in the selected year. When switching the shooting date selecting screen, the photos to be used are selected from the ones in the highlighted shooting date.
- A photo in an album with an aspect ratio other than 3:4, or one processed on the computer may be displayed rotated 90 degrees, or stretched horizontally or vertically during remix cube playback.

To set the photo selection, or to save the remix cube, follow the steps from step 2 on page 74.



● Playing a remix cube

– “PLAY” mode

To switch the mode from “SET” to “PLAY”

Touch  in the top right corner of the screen, then touch “▶ PLAY.”

How to play a remix cube

- 1 Select the remix cube that you want to play on the “PLAY” mode screen.
Display the remix cube using  (next) or  (previous).

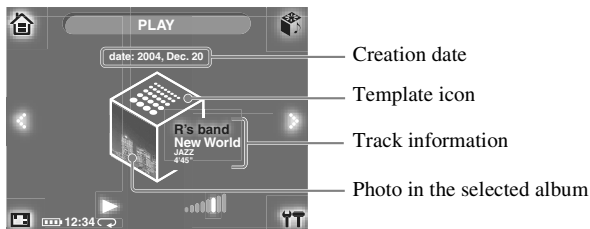



- 2 Touch  at the bottom of the screen.
Playback of the remix cube starts.
After playback is over, the “PLAY” mode screen reappears.

To stop playback

Touch the screen.
The “PLAY” mode screen reappears.

To adjust the volume

Touch  to display the volume adjust screen. Touch  to turn the volume up, or touch  to turn the volume down. After adjustment, touch outside the volume adjust screen to return to the previous screen.
Adjust the volume using the remote during playback.

Playing a remix cube repeatedly

You can set to play back a remix cube or all remix cubes in your m:robe repeatedly.

- 1 Touch **YT** in the bottom right corner of the screen.

The “REMIX SETTINGS” screen appears.

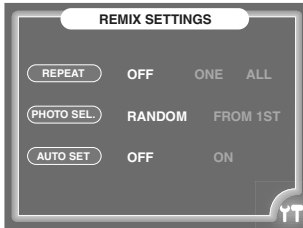



- 2 Touch “ONE” or “ALL” in “REPEAT.”

- “ONE”: play back one remix cube repeatedly.
- “ALL”: play back all remix cubes in your m:robe repeatedly.

- 3 Touch **YT** again.

The previous screen reappears, and the setting is complete.

When “REPEAT” is set to “ONE,”  appears, and when “REPEAT” is set to “ALL,”  appears at the bottom of the screen.



Tip

To disable the setting, touch “OFF” in Step 2.

Printing photos

You can print photos by connecting your m:robe and a PictBridge-compatible printer using the supplied dedicated USB cable. You can print photos in the “VIEW” mode of “PHOTO.”

This chapter explains how to print photos.

Printing with a PictBridge-compatible printer

– Direct printing function

You can print out photos in your m:robe directly by connecting your m:robe and a PictBridge-compatible printer using the supplied dedicated USB cable. With your m:robe connected to the printer, you can set the number of copies or the paper size and layout by touch-panel operation.

Refer to the instruction manual of your printer to confirm whether it is PictBridge-compatible.

What is PictBridge?

PictBridge is a standardized connecting convention for digital cameras and printers of different manufacturers for printing pictures directly.

About “STANDARD” setting

All printers that support PictBridge have standard print settings. Normally, the settings of the printing paper follow these settings. If you want to print with other settings, follow the procedure “Changing the paper settings” (👉 page 92). Refer to the instruction manual of your printer, or contact the manufacturer for details on the standard settings.



Tip

For details of printing paper types, ink cassettes, etc., refer to the instruction manual of your printer.



Note

We recommend using the AC adapter when connecting to your printer; if your m:robe stops operating while communicating with your printer, your printer may malfunction or data may be lost.

Connecting to your printer

- 1 Check that “USB CONNECTION” of your m:robe is set to “PRINTER.”

- ① Touch  in the bottom right corner of the “HOME” screen.

The “m:robe SETTINGS” screen appears.

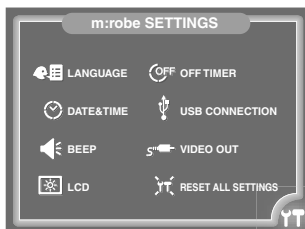

- ② Touch “USB CONNECTION.”

The “USB CONNECTION” screen appears.

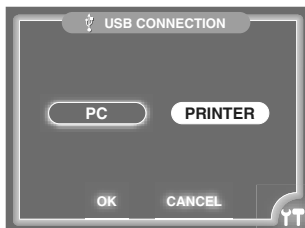

- ③ Check that “PRINTER” is selected.

If “PRINTER” is not selected, touch “PRINTER.”

- ④ Touch “OK.”

The “m:robe SETTINGS” screen reappears.

To return to the “HOME” screen

Touch  in the bottom right corner of the screen.

2 Connect your m:robe to the PictBridge-compatible printer using the supplied dedicated USB cable.

- ① Turn on the printer, and connect the supplied dedicated USB cable to the USB jack of the printer.
For details on how to turn on your printer, and the location of the USB jack, refer to the instruction manual of your printer.

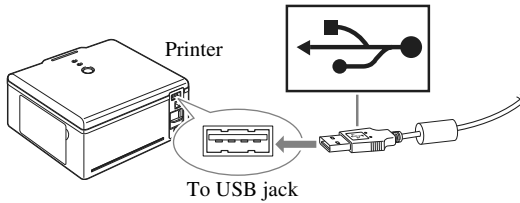

- ② Connect the AC adapter to the cradle.

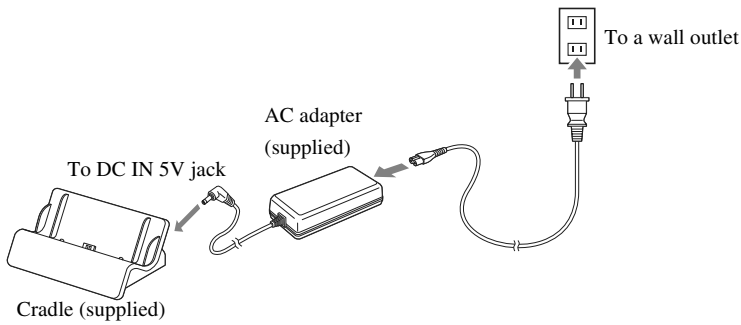

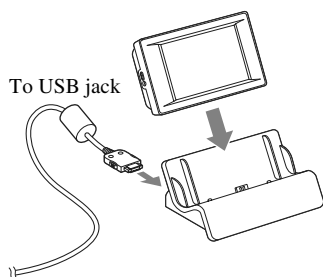

 **Tip**
Plug shape differs depending on country.

- ③ Connect the dedicated USB cable to the USB jack of the cradle, with the arrow marks on the connector facing down, then place your m:robe (already turned on) in the cradle.



The “CONNECTING” screen appears on your m:robe after connecting to the printer. After a while, the screen which was displayed before connecting to the printer reappears.

Printing photos

After connecting to the printer, if the “PHOTO” screen is not displayed, touch  on the “HOME” screen, or touch  in the top left corner of the “MUSIC”/“REMIX” screen, then touch “ PHOTO.”

If the “VIEW” mode screen of “PHOTO” is not displayed, touch  in the top right corner of the screen, then touch “▶ VIEW.”

While connected to the printer,  is displayed at the bottom of the screen.

After connecting your m:robe and the PictBridge-compatible printer, select the item or the photo to print and the print mode. The following 4 print modes are available:

- **PRINT** ( page 85)

Prints the selected photo.

Prints the photo which is highlighted on the search method “all” screen, or the one which is displayed in full screen.

- **MULTI PRINT** ( page 85)

Prints the selected photo in multiple layout format.

Prints the photo which is highlighted on the search method “all” screen, or the one which is displayed in full screen.

- **PRINT ALL** ( page 88)

Prints all photos in the selected item.

Prints all photos in a specific album (on the search method “album” screen) or in a specific date (on the search method “calendar” screen).

- **INDEX PRINT** ( page 88)

Prints an index of all photos in the selected item.

Prints an index of all photos in a specific album (on the search method “album” screen) or in a specific date (on the search method “calendar” screen).

Print mode and each setting

Available print options, such as printing modes and paper sizes, vary depending on the printer you use. For details, refer to the instruction manual of your printer.



Printing in the “PRINT”/“MULTI PRINT” mode

1 Select the photo to print.

• Printing the photo highlighted on the search method “all” screen

- ① If the search method “all” screen is not displayed, touch  repeatedly until “all” appears at the top right of the screen.



- ② Touch the desired photo, selecting from the thumbnail list using  (next) or  (previous). The selected photo is highlighted.



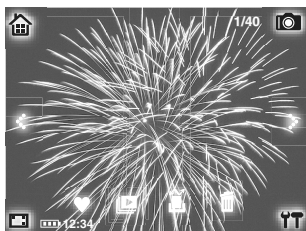

• Printing the photo displayed in full screen

Search for a photo on the search method “all”/“album”/“calendar” and display it in full screen.



Tip

For details on how to display a photo in full screen, refer to the sections of each search method.

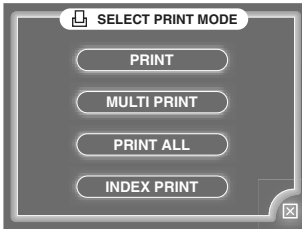

- Search method “all” ( page 54)
- Search method “album” ( page 56)
- Search method “calendar” ( page 57)

- 2** Touch  at the bottom of the screen.
The “SELECT PRINT MODE” screen appears.

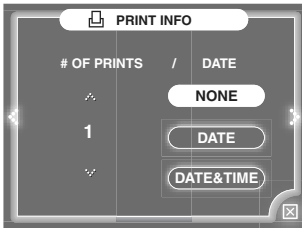

- 3** Touch “PRINT” or “MULTI PRINT.”
The “PRINT INFO” screen appears.



- 4** Set the number of copies in “# OF PRINTS” using  (increase) or  (decrease).
- 5** Touch “NONE,” “DATE” or “DATE&TIME” in “DATE,” if you selected “PRINT” in step 3.
- “NONE”: prints only photos.
 - “DATE”: prints the shooting date.
 - “DATE&TIME” prints the shooting date and time.



Tip



If you select “MULTI PRINT” in step 3, you cannot print the shooting date or time.

6 Touch .

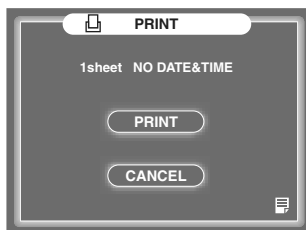
The “PRINT” screen appears.



Tip

You can change the paper settings on the screen displayed by touching  in the bottom right corner of the screen. For details, refer to “Changing the paper settings” ( page 92).

7 Touch “PRINT.”

Printing starts, and the “NOW PRINTING” screen appears.

If you want to cancel printing mid-way, touch “SUSPEND,” then touch “CANCEL.”

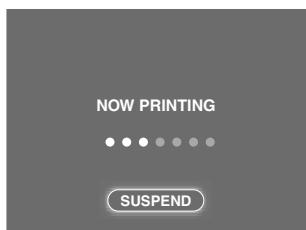

Note

Do not disconnect your m:robe from the printer while the “NOW PRINTING” screen is displayed.

The screen displayed in step 1 reappears after printing is complete.



Tip

Touch  in the bottom right corner of the “SELECT PRINT MODE”/“PRINT INFO” screen, or select “CANCEL” in step 7 to return to the screen displayed in step 1.

Printing in the “PRINT ALL”/“INDEX PRINT” mode



Tips



- You can print up to 250 photos in the “PRINT ALL”/“INDEX PRINT” mode. If the number of photos in “FAVORITES” or the selected shooting date goes beyond this limitation, the first to the 250th photo imported to m:trip will be printed. To continue printing from the 251st photo, print them one by one in the “PRINT” mode.
- The number of photos per sheet in the “INDEX PRINT” mode is set automatically by the printer.
- The “INDEX PRINT” is not available with printers which do not support the index function.

1 Select the item to print.

- **Printing all photos in an album**

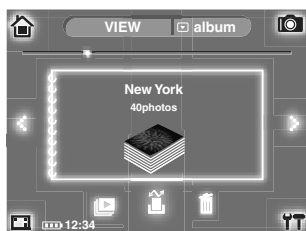
- ① If the search method “album” screen is not displayed, touch  repeatedly until “album” appears at the top right of the screen.





- ② Select the desired album using  (next) or  (previous).



• **Printing all photos in a shooting date**

- ① If the search method “calendar” screen is not displayed, touch  repeatedly until “calendar” appears at the top right of the screen.



- ② Select the shooting year using  (next) or  (previous), and touch the shooting month.



- ③ Touch the date, selecting from the list using  (next) or  (previous). The photo in the selected date is highlighted.

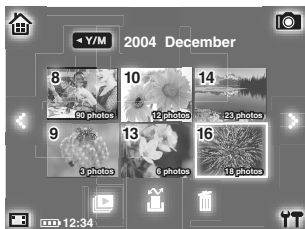

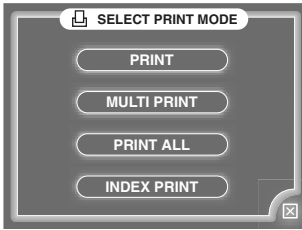

- 2 Touch  at the bottom of the screen.
The “SELECT PRINT MODE” screen appears.

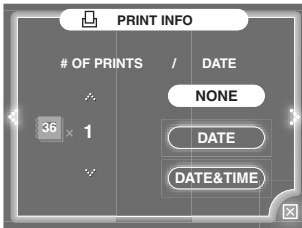

- 3 Touch “PRINT ALL” or “INDEX PRINT.”
The “PRINT INFO” screen appears.



- 4 Set the number of copies in “# OF PRINTS” using  (increase) or  (decrease).
- 5 Touch “NONE,” “DATE” or “DATE&TIME” in “DATE,” if you selected “PRINT ALL” in step 3.
- “NONE”: prints only photos.
 - “DATE”: prints the shooting date.
 - “DATE&TIME” prints the shooting date and time.



Tip



If you select “INDEX PRINT” in step 3, you cannot print the shooting date or time.

6 Touch .

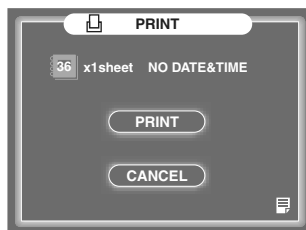
The “PRINT” screen appears.



Tip

You can change the paper settings on the screen displayed by touching  in the bottom right corner of the screen. For details, refer to “Changing the paper settings” ( page 92).

7 Touch “PRINT.”

Printing starts, and the “NOW PRINTING” screen appears.

If you want to cancel printing mid-way, touch “SUSPEND,” then touch “CANCEL.”

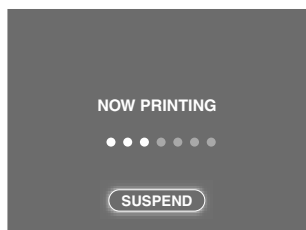

Note

Do not disconnect your m:robe from the printer while the “NOW PRINTING” screen is displayed.

The screen displayed in step 1 reappears after printing has complete.



Tip

Touch  in the bottom right corner of the “SELECT PRINT MODE”/“PRINT INFO” screen, or select “CANCEL” in step 7 to return to the screen displayed in step 1.

Changing the paper settings

You can change the settings of the printing paper.

Normally, the settings of the printing paper follow the STANDARD settings of your printer.

Printing in the “PRINT”/“PRINT ALL” /“INDEX PRINT” mode

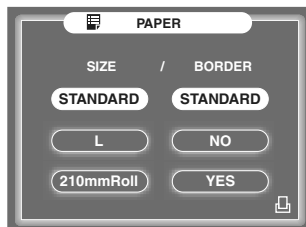

Printing in the “MULTI PRINT” mode

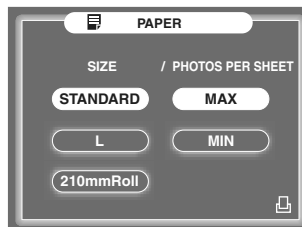

- SIZE
- The paper size setting value differs depending on the printer.
- BORDER
 - STANDARD: prints according to the settings of your printer.
 - NO: prints to the edges of the paper.
 - YES: prints with borders.
- PHOTOS PER SHEET

The setting value differs depending on the selected paper size and the printer.

Touch the desired settings on each screen above. Touch  to return to the “PRINT” screen and to complete the settings.

Tip

If you change the paper settings, these changes will be kept until you finish direct printing.

Next time you connect your m:robe to the printer, the paper size settings will be the STANDARD settings.

Playing back on a TV

You can enjoy playback of music, photos or remix by connecting to your TV using the supplied AV cable.

● Setting the video signal type

Set the video signal to NTSC or PAL according to your TV video signal type.



About video signals

- **NTSC (National Television Systems Committee)**

Mainly used in the USA, Canada, Japan, South Korea, etc.

- **PAL (Phase Alternating Line)**

Mainly used in Europe, China, etc.

If the “HOME” screen is not displayed, touch  in the top left corner of the screen, then touch “ HOME.”

- 1 Touch  in the bottom right corner of the “HOME” screen to display the “m:robe SETTINGS” screen, then touch “VIDEO OUT.”

The “VIDEO OUT” screen appears.



- 2 Touch “NTSC” or “PAL.”

- 3 Touch “OK.”

The “m:robe SETTINGS” screen reappears, and the setting is complete.

To return to the “HOME” screen

Touch  in the bottom right corner of the screen.

● Connection and playback on a TV

! Notes

- Set the TV volume to minimum when connecting the AV cable to the TV.
- Adjust your m:robe volume observing the TV volume to avoid sudden high volume output.

1 Connect the cradle and the TV using the supplied AV cable, and connect the AC adapter to the cradle.

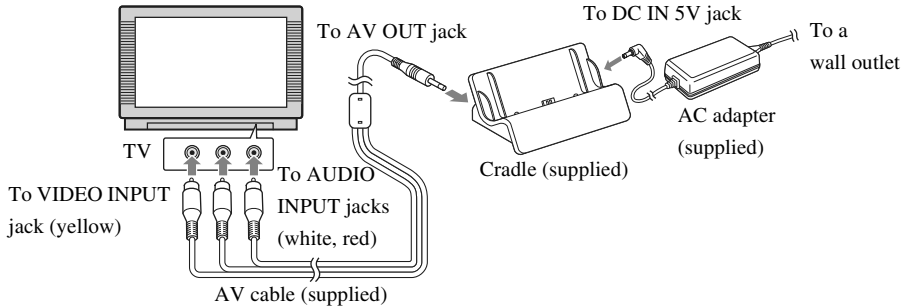

2 Place your m:robe in its cradle.

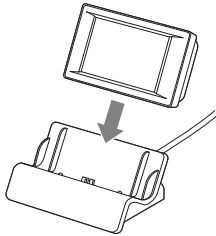

- 3 Play back the music, photo (including slide show), or remix cube that you want to output to the TV, then adjust the volume of your m:robe and your TV.

**Tip**

You can perform basic operations, such as skipping tracks, with the supplied m:robe remote when playing back music.

- 4 Press HOLD on your m:robe.

The screen being displayed is output to the TV.

To stop the TV output

Press HOLD.



**Tip**

For details on the audio/video input jacks of the TV, refer to the instruction manual of your TV.

Setting your m:robe

● Setting the display language



You can set a desired display language.

If the “HOME” screen is not displayed, touch  in the top left corner of the screen, then touch “ HOME.”

- 1 Touch  in the bottom right corner of the “HOME” screen to display the “m:robe SETTINGS” screen, then touch “LANGUAGE.”

The “LANGUAGE” screen appears.



- 2 Touch the desired language, selecting from the list using  (down) or  (up).
- 3 Touch “OK.”

The “m:robe SETTINGS” screen reappears, and the setting is complete.



Tip



To cancel the setting, touch “CANCEL” in step 3.

To return to the “HOME” screen

Touch  in the bottom right corner of the screen.

● Setting the date and time



You can set the date and time. (The time is displayed at the bottom left of the screen.)

If the “HOME” screen is not displayed, touch  in the top left corner of the screen, then touch “ HOME.”

- 1 Touch  in the bottom right corner of the “HOME” screen to display the “m:robe SETTINGS” screen, then touch “DATE&TIME.”

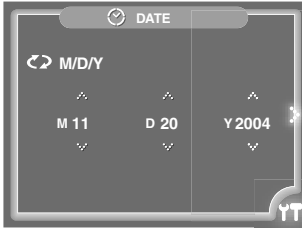
The “DATE” screen appears.



- 2 Set “M” (month), “D” (day) and “Y” (year) using  (forward) or  (back). Touch  repeatedly if you want to change the order of “M/D/Y.”



Tip

The default setting of this order differs, depending on the country where the product was purchased.

- 3 Touch .

The “TIME” screen appears.



4 Set the hour and minute using ⏸ (forward) or ⏮ (back).

Touch  to select 24 hour indication.

5 Touch “OK.”

The “m:robe SETTINGS” screen reappears, and the setting is complete.



Tip

To cancel the setting, touch “CANCEL” in step 5.

To return to the “HOME” screen

Touch  in the bottom right corner of the screen.



Turning the beep sound on/off

You can turn the beep sound of your m:robe on or off.



Tip

The beep sound cannot be turned off when you take a photo, even if you set “BEEP” to “OFF.”

If the “HOME” screen is not displayed, touch  in the top left corner of the screen, then touch “ HOME.”

- 1 Touch  in the bottom right corner of the “HOME” screen to display the “m:robe SETTINGS” screen, then touch “BEEP.”

The “BEEP” screen appears.

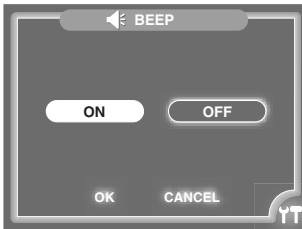

- 2 Touch “OFF” or “ON.”
- 3 Touch “OK.”

The “m:robe SETTINGS” screen reappears, and the setting is complete.



Tip



To cancel the setting, touch “CANCEL” in step 3.

To return to the “HOME” screen

Touch  in the bottom right corner of the screen.

● Setting the brightness and the backlight time of the LCD screen



You can adjust the brightness of the screen, and set the duration for the backlight to turn on after operating your m:robe.

If the “HOME” screen is not displayed, touch  in the top left corner of the screen, then touch “ HOME.”

- 1 Touch  in the bottom right corner of the “HOME” screen to display the “m:robe SETTINGS” screen, then touch “LCD.”

The “LCD” screen appears.



- 2 In “BRIGHTNESS,” touch  (right) to brighten the screen, or touch  (left) to darken the screen.
- 3 Touch “3sec,” “15sec,” “30sec” or “ON” in “BACKLIGHT.”
- 4 Touch “OK.”

The “m:robe SETTINGS” screen reappears, and the setting is complete.



Tips



- You will experience longer battery life if you operate your m:robe with the LCD on a low brightness setting, and the backlight is set to a low duration (such as 3 seconds).
- To cancel the setting, touch “CANCEL” in step 4.

To return to the “HOME” screen

Touch  in the bottom right corner of the screen.

● Setting the Off Timer

You can set your m:robe to turn off after a specified time.

If the “HOME” screen is not displayed, touch  in the top left corner of the screen, then touch “ HOME.”

- 1 Touch  in the bottom right corner of the “HOME” screen to display the “m:robe SETTINGS” screen, then touch “OFF TIMER.”

The “OFF TIMER” screen appears.



- 2 Touch “30min,” “60min” or “90min.”

- 3 Touch “OK.”

The “m:robe SETTINGS” screen reappears, and the setting is complete.



Tip

To cancel the setting, touch “CANCEL” in step 3.

To disable the Off Timer



Touch “OFF” in step 2.

To return to the “HOME” screen

Touch  in the bottom right corner of the screen.

● Resetting the settings

You can reset all m:robe settings to the default settings.

If the “HOME” screen is not displayed, touch  in the top left corner of the screen, then touch “ HOME.”

- 1 Touch  in the bottom right corner of the “HOME” screen to display the “m:robe SETTINGS” screen, then touch “RESET ALL SETTINGS.”

The “RESET ALL SETTINGS” screen appears.



- 2 Touch “OK.”

The “Are you sure?” message screen appears.

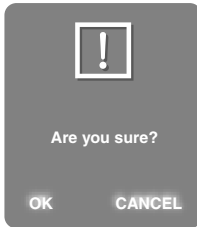

- 3 Touch “OK” again.

The “The default settings are restored” message appears, and the resetting is complete.



Tip

To cancel the setting, touch “CANCEL” in step 2 or 3.

To return to the “HOME” screen

Touch  in the bottom right corner of the screen.

Additional Information

● Using your m:robe as an external hard disk drive

The computer can recognize your m:robe as an external hard disk drive.

You can store non-audio/image data and carry it with you.



Notes

- Never add/edit/delete any file in the System folder of the m:robe hard disk or the folder itself, or change the name of a file or the folder as malfunction of your m:robe may occur.
- You cannot play back files that are transferred from software other than the supplied Music/Photo Organization Software "m:trip." Do not write/delete data in the m:trip folder using your computer, such as Windows Explorer, etc.

● Cleaning

Exterior

Wipe gently with a soft cloth. If the device is very dirty, wipe it with a cloth damped with a detergent. If you used the device at the beach, clean it with a damp cloth.

Liquid crystal display

Wipe any dust or dirt on the LCD gently with a soft cloth.



Note

Do not use strong solvents such as benzene or alcohol, or chemically treated cloths.

Notes when you dispose of your m:robe

Remove the built-in battery when you dispose of this product. Never disassemble this product except when disposing of it.

Danger

- **Do not allow the +/- terminals of the built-in battery to come in contact with metal objects, or subject the built-in battery to strong shock.** Also, do not carry or store with a necklace or hairclip, etc. This may cause short-circuiting, resulting in overheating, explosion or fire.
- **Do not heat, disassemble or modify the built-in battery, expose it to water, or leave it in scorching heat.** Doing so may cause over-heating, explosion or fire.
- **Do not pierce with a nail, beat with a hammer, throw or step on the built-in battery.** Doing so may cause over-heating, explosion, fire or battery leakage.
- **Before disposing, tape the connector of the built-in battery with insulating tape.** Otherwise, short-circuiting may occur, resulting in explosion or fire.

Warning

- **Keep the built-in battery out of the reach of children.** Failure to do so may cause accident or injury.
- **When battery leakage has occurred and the liquid gets into your eyes, wash immediately with clean water and seek medical attention immediately.** Failure to do so may cause eye injury.

How to remove the built-in battery

- 1 Press and hold POWER until the LED flashes to turn off your m:robe.
- 2 Remove the screws at the side of device using the screwdriver.

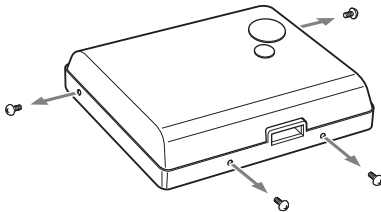

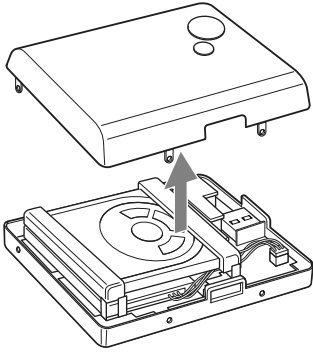
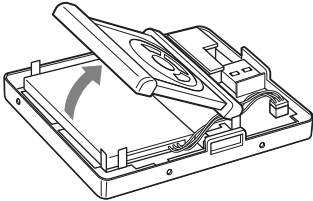
3 Remove the rear cabinet.**4** Lift the hard disk.**5** Remove the built-in battery.

Remove the two-sided tape from the battery, lift it out, and disconnect the connector.

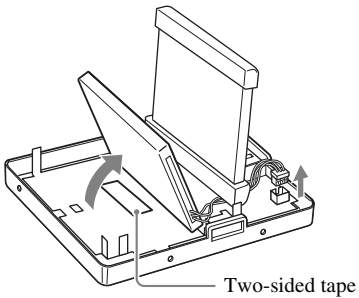

6 Tape the cable to the battery body, and put the battery in a plastic bag, etc.

Cover the connector with tape before you put the battery in a plastic bag.



Notes

- Check that the battery is completely drained before removing it.
- Make sure that your m:robe is turned off before removing the battery.
- Do not reuse the battery once it has been removed.
- At your earliest opportunity, return the removed built-in battery to a recycling location.
- When you dispose of this product, you should obey local ordinance or rule of your municipality. For details, contact your local authority.

Troubleshooting

Before sending the product for repair, refer to the following checklist to resolve the problem. If the problem persists, contact your nearest Olympus service center.

In addition, be sure to back up the data before sending this product for repair or service. Writing to the hard disk or deleting data, etc., may be necessary during the repair or service.

Due to copyright restrictions, we cannot copy stored data for repair or service. Restoring the data is not available. We also recommend backing up your data often, by synchronization, to prevent data loss problems.

Problem	Cause	Solution	Page
The power cannot be turned on.	The battery is empty.	Charge the battery with the supplied AC adapter.	23
	The operation of the device is unstable.	Reboot the device.	108
The power turns off automatically.	Off Timer is set.	The power turns off automatically after the preset time of the Off Timer has elapsed. Set to "OFF" to disable the Off Timer setting.	101
	The Auto Off function is activated.	If playback of music, slide show or remix is stopped and no operation is performed for more than 10 minutes, the device automatically turns off. Turn on the device by pressing POWER.	27
	The battery is discharged.	Charge the battery with the supplied AC adapter.	23

Problem	Cause	Solution	Page
Touch Panel does not work.	The HOLD function is set to ON.	Press HOLD to release the HOLD function.	22
The device becomes hot.	The temperature of the device increases after extended periods of operation.	This is not a malfunction.	-
The battery discharges soon after charging.	The battery should be replaced.	The built-in battery is good for about 500 complete charges and discharges, depending on usage. If the battery discharges soon after charging, contact your nearest Olympus service center for battery replacement.	-
Nothing is displayed on the screen.	The battery is empty.	Charge the battery with the supplied AC adapter.	23
	The HOLD function is set to ON.	The screen disappears when HOLD is set to ON. Press HOLD to release the HOLD function.	22
The screen is dark.	The LCD brightness setting is too low.	Adjust the setting of the LCD brightness.	100
The backlight of the screen turns off.	The backlight is set to turn off.	Set the desired time or change "BACKLIGHT" to "ON."	100
There is no sound.	The volume is set to minimum.	Adjust the volume on the device or remote.	20 34 69 78
	The remote or headphones are not connected properly.	Check whether the remote/headphones are connected to the device properly.	21
The image is out of focus.	The subject is too close.	Always be at least 40 cm (15 3/4 in.) from the subject when shooting.	-
	The device moved during shooting when you touched the screen.	Hold the device firmly and touch the center of the screen lightly to avoid blur when shooting.	48

Problem	Cause	Solution	Page
Photos cannot be printed.	The "USB CONNECTION" is set to "PC."	Set "USB CONNECTION" to "PRINTER."	81
	The connected printer is turned off.	Turn on the printer.	-
	The printer is not PictBridge-compatible.	Refer to the instruction manual of your printer to confirm whether it is PictBridge-compatible.	-
Nothing is displayed on the TV after connecting.	This product and the TV are not connected properly.	Check whether the cradle and the TV are connected properly.	94
	The screen output is not set to TV.	Set the screen output of this product to TV by pressing HOLD.	94
A file that you have transferred is not found.	The file was transferred using Windows Explorer, etc.	Files that are not transferred from the supplied Music/Photo Organization Software "m:trip" cannot be displayed. Synchronize with m:trip.	27
Synchronization is not happening.	The "USB CONNECTION" is set to "PRINTER."	Set "USB CONNECTION" to "PC."	27
	This product and the computer are not connected properly.	Check whether the USB cable is connected properly.	27
	The device is turned off.	Press POWER to turn on the device.	27
	The battery is discharged.	Charge the battery with the supplied AC adapter.	23

Rebooting your m:robe

If a problem persists after trying the suggested solution, rebooting your m:robe may solve the problem. To reboot your m:robe, press ►||, ♥ and MODE on the remote for 3 seconds simultaneously.

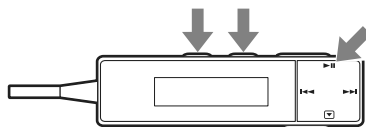







If the problem persists even after rebooting your m:robe, contact your nearest Olympus service center.

 **Tip**







Rebooting your m:robe does not delete data.

Error message list

Error messages of the device

Error messages	Cause	Solution
 BATTERY EMPTY	The battery is empty.	Charge the battery.
 REMAINING STORAGE CAPACITY IS 0	The file you are trying to store is beyond the remaining capacity, or there is not enough space on the hard disk.	Delete unnecessary files.
 CANNOT PLAY THIS FILE	The selected file has a problem or is not supported by this product, and cannot be played back.	
 FAILED TO CONNECT CHECK YOUR CONNECTION AND TRY AGAIN	This product and the computer are not connected properly, or an error occurred while communicating with the computer.	Take the device out of the cradle, and retry connection.
 CANNOT FIND THIS FILE	The file has been uploaded from software other than m:trip.	Synchronize with your computer.
 DATABASE ERROR PLEASE RECONNECT TO PC	Some errors were found in the database that manages files.	Synchronize with your computer.
 FATAL SYSTEM ERROR xxx: SERVICE REQUIRED	An error has occurred in this product.	Contact your nearest Olympus service center.

Error messages when setting for direct printing

Error messages	Cause	Solution
 FAILED TO CONNECT CHECK YOUR CONNECTION AND TRY AGAIN	This product is not connected correctly to the printer.	Reconnect this product and the printer correctly.
 NO PAPER	There is no paper in the printer.	Load some paper in the printer.
 NO INK IN PRINTER	The printer has run out of ink.	Replace the ink cartridge in the printer.
 PAPER JAM	Paper is jammed in the printer.	Remove jammed paper.
PRINTER SETTINGS HAVE CHANGED	An operation has performed on the printer, such as removing the paper tray, etc.	Do not operate the printer while setting for direct printing.
 PRINTER ERROR	An error has occurred.	Turn off this product and the printer, check the printer condition, and turn them on again.
 CANNOT PRINT THIS IMAGE	Some photos taken by other devices may not be printed with this product.	Print them using the computer, etc.

● Service and maintenance

- The product will come with a warranty card. Make sure that the dealer name and purchase date are written or stamped on the warranty. If any of the necessary information is missing, contact the dealer. Please read through the warranty and store it in a safe place.
- If you have a query about after-sale services for this product or encounter a failure, contact the dealer or our service center. Within one year of the purchase date, we will repair the product free of charge if it becomes faulty, provided that the instructions in this manual were observed.
- Maintenance parts for this product will be stored for about five years after production stops. Within this period, we can accept repair requests. Even after this period, repair may be possible. Contact the dealer or our service center.
- Olympus will not compensate for any damage or loss (including cost to purchase/obtain audio files, or photography costs/profit loss) incurred as a consequence of a failure of this product. Postage and packing costs are the responsibility of the sender.
- When sending this product to us for maintenance, pack the product with sufficient cushioning to avoid damage during transportation. Use a door-to-door package delivery service or registered parcel mail so that you have proof of sending the product.
- Ownership of removed parts during repair will belong to us.
- Stored data on the hard disk may be lost as writing to the hard disk or deleting data, etc., may be necessary during repair or service. Be sure to back up your data before sending this product for repair or service. Olympus will take no responsibility for any loss due to changes of stored data.
- We cannot accept any request for the recovery/restoration of lost data.
Due to copyright restrictions, we cannot copy stored data for repair or service. Therefore, we may not be able to accept repair of service where restoring data is required.

Specifications

Product name	DIGITAL AUDIO PLAYER
Model name	MR-500i
Built-in battery	Lithium-polymer rechargeable battery
Weight	Approx. 210 g (8 oz.) (body only)
Dimensions	Approx. 109 × 73 × 21 mm (4 ³ / ₈ × 3 × 27/ ₃₂ in.) (W × H × D Protruding parts excluded)
Monitor	3.7" TFT color LCD display (width 640 × height 480 pixels), approx. 260,000 colors
Storage	Built-in hard disk 20 GB ^{*1}
Supported audio file formats	<ul style="list-style-type: none"> • Windows Media Audio (WMA) • MPEG-1/2 Audio Layer3 (MP3)
Number of storable tracks	Approx. 5,000 tracks ^{*2}
Continuous audio playback time	<ul style="list-style-type: none"> • Approx. 8 hours (WMA)^{*3} • Approx. 8 hours (MP3)^{*3}
Bit rate	<ul style="list-style-type: none"> • WMA: 32 to 192 kbps (including VBR) • MP3: 8 to 320 kbps (including VBR)
Image recording format	JPEG
Compatible standards	Exif 2.2, PictBridge
Number of storable photos	Approx. 20,000 photos ^{*4}
Operating conditions	<ul style="list-style-type: none"> • Temperature: 5 to 35 °C (41 to 95 °F) • Humidity: 30 to 90 % (no condensation)
Charge time	Approx. 3 hours
USB port	USB 2.0
Headphones jack	3.5 mm jack/stereo type 22 ohm load impedance

^{*1} 1 GB = 1 billion bytes: the actual formatted capacity is somewhat less.
(The actual capacity after formatting will be less than 20 GB.)

^{*2} When storing music tracks only.

Considering WMA formatted 128 kbps audio file as 4-minute music track.

^{*3} When playing WMA/MP3 formatted 128 kbps, 44.1 kHz audio data at room temperature (25 °C (77 °F)), with the HOLD function of the device set to ON (screen off), and with the audio volume set to a medium level.

This value is subject to the operating conditions, ambient temperature, number of charging/discharging times, etc., and is for reference only and is not guaranteed.

^{*4} When storing only 4 megapixel photos.

Camera specifications

Number of effective pixels	1,220,000 pixels (1280 × 960)
Image pickup device	1/4" MOS (primary color filter)
Shutter shooting distance	40 cm (1 5/8 in.) to ∞

AC adapter specifications

Type	Switching regulator
Input	100 - 240 V AC, 50/60 Hz
Output	DC 5V, 2A

Cradle specifications

Dimensions	Approx. 110 × 43 × 60 mm (4 3/8 × 1 3/4 × 2 3/8 in.) (W × H × D Protruding parts excluded)
Weight	Approx. 85 g (3 oz.)
Interface	DC IN 5V jack, USB jack, AV OUT jack

Specifications and design are subject to change without notice due to product improvement.

Index

A

AC adapter	15
Adding	45, 64, 65
Album	56, 60, 65
ALBUM mode	65
Album to store	49
Audio CD	4, 26
Audio file	4, 30, 45
Auto Off	27
AV cable	94

B

BACKLIGHT	100
Battery	17, 20, 23, 104
BEEP	99
BRIGHTNESS	100

C

Charging	23
Computer	27, 29
Connection	27, 81, 94
Cradle	14, 23, 28, 82, 94

D

Date and time	97
Deleting	45, 62
Direct printing	80
Display language	96

E

EQ	38
Equalizer	38

F

FAVORITES	40, 45, 55, 56, 58, 64
FAVORITES album	64
FAVORITES list	45

H

Headphones	21
HOLD	22
HOME screen	19

I

Image file	30, 31, 62
Image size	50
INDEX PRINT	88
info	36
Information	36

J

Jacket photo	36
--------------------	----

L

LCD screen	100
Liquid crystal display	14, 19, 47, 103
list	32
lyrics	37

M

m:trip	24, 25, 26, 27, 30
MULTI PRINT	85
MUSIC	32

N

NTSC	93
------------	----

O

Off Timer	101
-----------------	-----

P

PAL	93
PHOTO	46
Photo light	51
PictBridge	80
PLAY mode	32, 78
Playback	32, 78, 93
PLAYLISTS	41
POWER	27
Preview playback	75
PRINT	85
PRINT ALL	88
Print mode	84
Printer	80, 81
Printing	80

R

RANDOM	20, 35
Rebooting	108
REMIX	67
Remix cube	67, 78
Remix data	31
Remix template	67, 68
Remote	20, 21
Removing	60
REPEAT	20, 35, 79
Resetting the settings	102

S

Search	40, 41, 52, 54, 56, 57
Search method “album”	56
Search method “all”	54
Search method “calendar”	57
SEARCH mode	40
Search record	44
SET mode	67
SHOOT mode	46
Shooting	48
Slide show	59
STANDARD	80
Synchronization	30

T

Thumbnail	54, 65, 66
Transferring	27
TV	93

U

USB cable	28, 82
USB CONNECTION	27, 81

V

Video signal type	93
VIEW mode	52
Volume adjust	20, 34, 69, 78

Before you contact us

- Confirm the following points before contacting us so that we can provide quick and accurate answers.
- Please fill out this check sheet if you want to contact us by fax or mail.
- Symptom, displayed messages, frequency, and other details of the problem:
PC-related problems are difficult to accurately identify. Please provide as much detail as possible.

- Name:
- Contact information: Postal code
Address (your residential address or office address)
Phone/Fax
E-mail
- Product name (model):
- Serial number (located on the bottom of the product):
- Purchase date:
*Please provide the following information if you are using the storage unit connected to a PC, or if you are using third party application software:
 - Type of PC:
Manufacturer, model, and others
 - Memory size and free hard disk space:
 - Type of operating system and version:
Settings on Control Panel/System/Device Manager:
 - Other peripheral devices connected:
 - Name and version of the application software related to your problem:
 - Name and version of the OLYMPUS software product related to your problem:

OLYMPUS®

<http://www.olympus.com/>

OLYMPUS IMAGING CORP.

Shinjuku Monolith, 3-1 Nishi-Shinjuku 2-chome, Shinjuku-ku, Tokyo, Japan

OLYMPUS IMAGING AMERICA INC.

Two Corporate Center Drive, PO Box 9058, Melville, NY 11747-9058, U.S.A. Tel. 631-844-5000

Technical Support (USA)

24/7 online automated help: <http://www.olympusamerica.com/support>

Phone customer support: Tel. 1-888-553-4448 (Toll-free)

Our phone customer support is available from 8 am to 10 pm
(Monday to Friday) ET

E-Mail: distec@olympus.com

Olympus software updates can be obtained at: <http://www.olympus.com/digital>

OLYMPUS EUROPA GMBH

Premises: Wendenstrasse 14-18, 20097 Hamburg, Germany

Tel: +49 40-23 77 3-0 / Fax: +49 40-23 07 61

Goods delivery: Bredowstrasse 20, 22113 Hamburg, Germany

Letters: Postfach 10 49 08, 20034 Hamburg, Germany

European Technical Customer Support:

Please visit our homepage <http://www.olympus-europa.com>

or call our TOLL FREE NUMBER* : **00800 - 67 10 83 00**

for Austria, Belgium, Denmark, Finland, France, Germany, Italy, Luxemburg, Netherlands,
Norway, Portugal, Spain, Sweden, Switzerland, United Kingdom

- Please note some (mobile) phone services/provider do not permit access or request an additional prefix to +800 numbers.

For all not listed European Countries and in case that you can't get connected to the above mentioned number please make use of the following

CHARGED NUMBERS: **+49 180 5 - 67 10 83 or +49 40 - 237 73 899**

Our Technical Customer Support is available from 9 am to 6 pm MET (Monday to Friday)